

Hinged Bathscreen

Installation & Maintenance Instructions

11.24

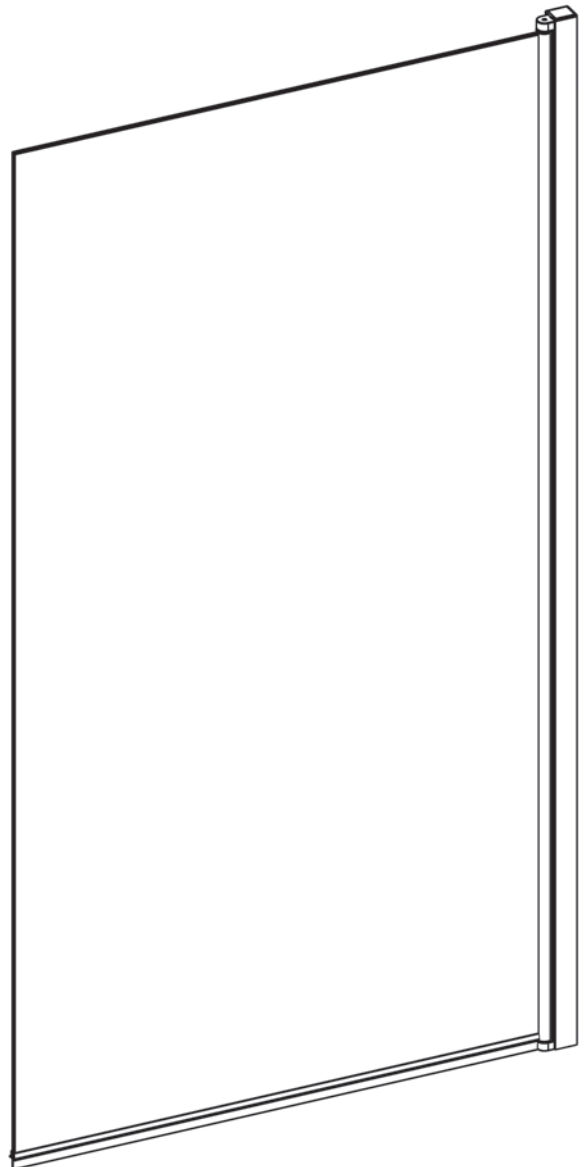
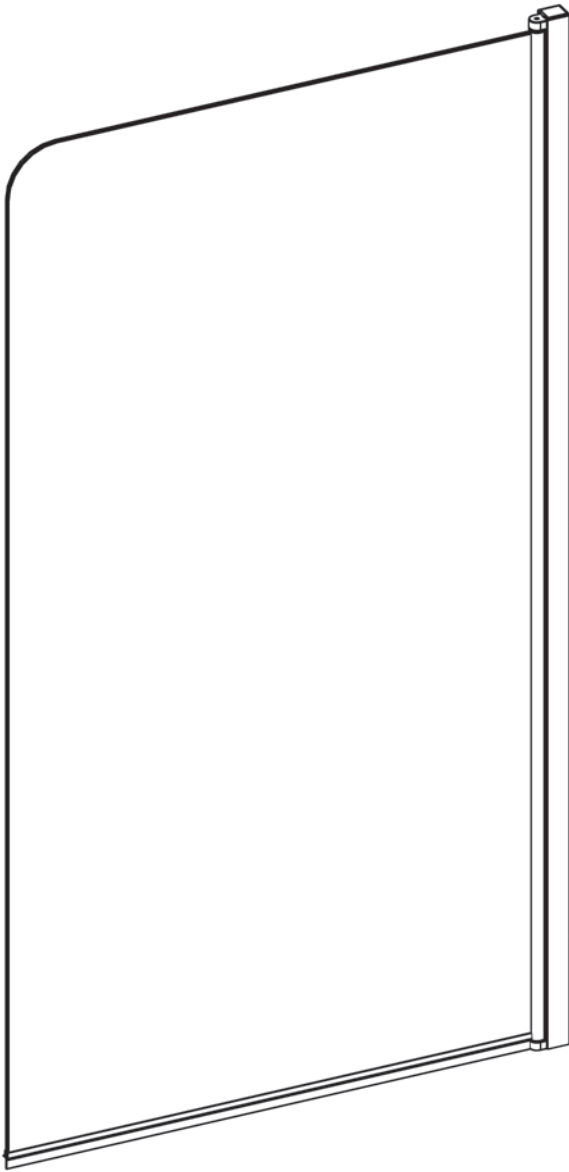

Parts:

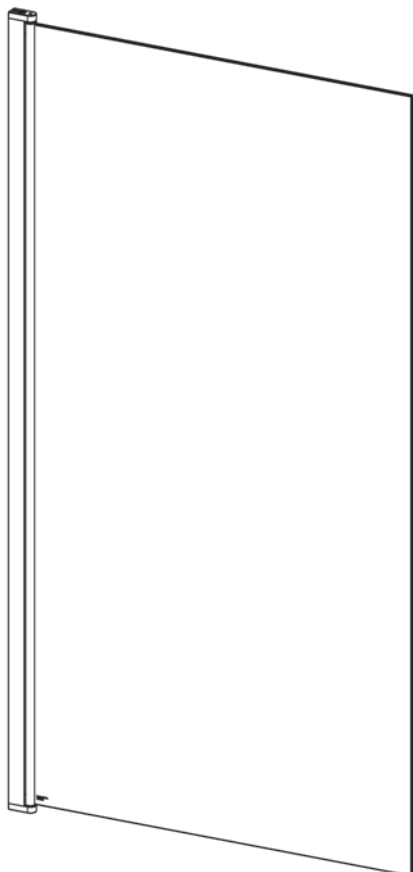

Bathroom Assy x1

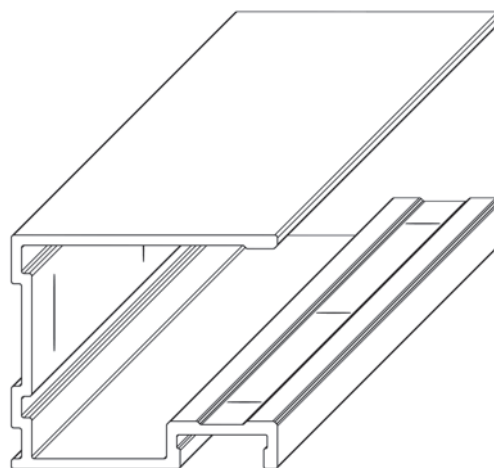

Wall Profile x1

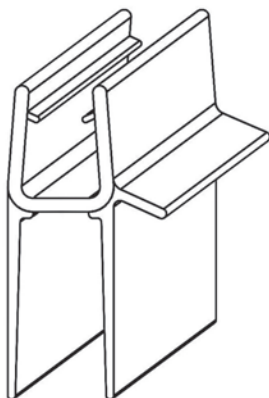

Bottom seal x1

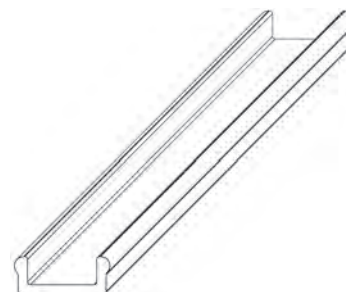

Screw cover strip x1

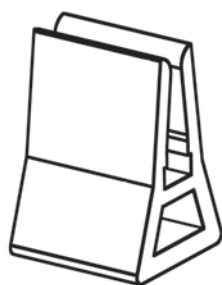

Glass support x1

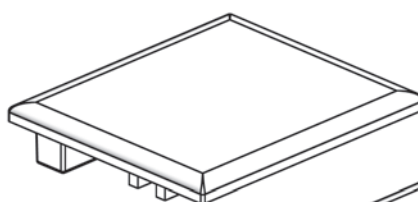

Wall Profile Cap
(handed pair)

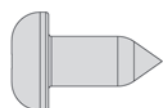
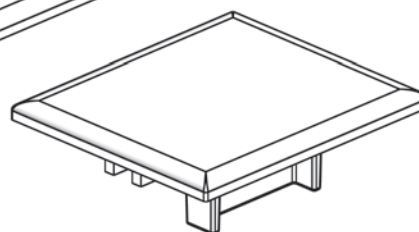

3,5 x 8mm Long
screw x3



4 x 35mm Long
screw x3

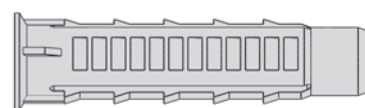

Wall plug x3

Bathscreen adjustment range 800 - 815mm

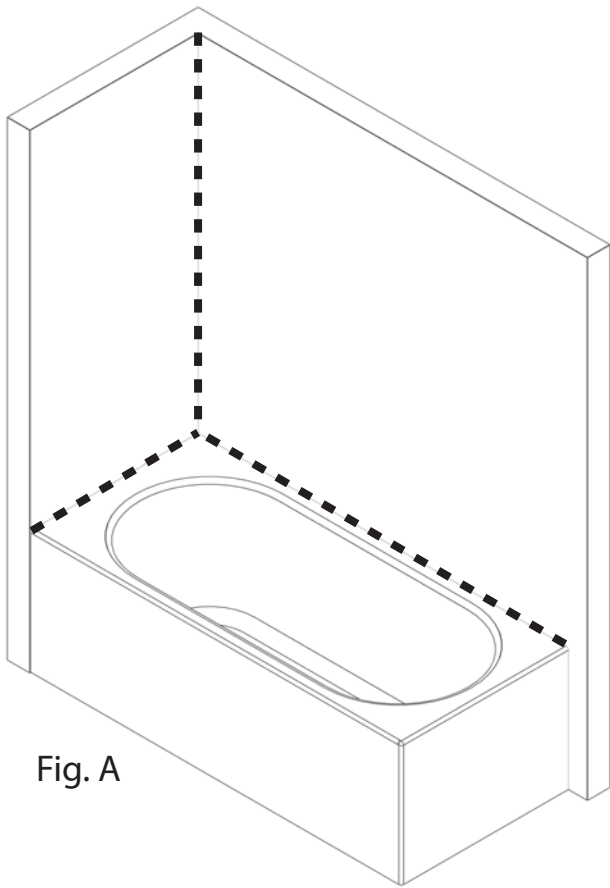

Fig. A

Bathscreen is fully reversible so is suitable for fitting with opening to left or right hand side of bathtub.

Ensure bathtub is correctly levelled & that tray / wall (tile) joints are sealed & cured over entire length of tray sides (See Fig A) prior to fitting enclosure.

DO NOT SEAL BATHTUB UP TO A FITTED BATHSCREEN!

Tools Required:

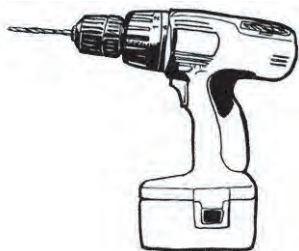

Power drill & 6mm masonry or tile bit

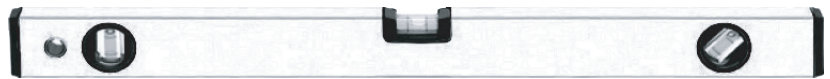

Spirit level



3mm HSS drill bit

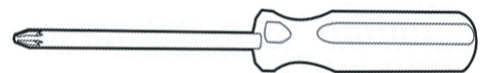

Pozi driv screwdriver



Good quality silicone sealant & applicator



Seal cutter



Pencil

IMPORTANT NOTES :

Please read carefully & retain these instructions for future reference.

1. For ease & safety we advise that two persons assemble this product.
2. Protect bathtub surface at all times.
3. Exposed glass corners/edges MUST NOT contact hard surfaces at any time.
4. Check for cables, pipes etc. before drilling walls.
5. Ensure all surfaces are dry, clean & free from loose debris or dust.
6. Unpack goods with care (small parts can become lodged in packaging and inadvertently discarded)
Check parts supplied against parts and fittings listed herein.
Damaged parts / omissions may be resolved by calling helpline.
7. Whilst precautions are taken in manufacture, care must be taken when handling as rail ends may have sharp edges.
8. Before commencing, check that :
 - a) Bathtub is level & completely sealed to finished / tiled walls.
 - b) finished walls are sound and free of cracks, loose tiles / grout.
9. AFTER INSTALLATION DO NOT WET BATHTHRESHOLD FOR 48 HOURS TO ENSURE FULL CURE OF SILICONE SEALANT.

Use :

General Care & Maintenance.

Provided this product is installed and operated in accordance with these instructions problems should not arise however should maintenance be required it should be carried out by a competent person with reference to these instructions. Before any work is carried out, the root cause of the problem must be identified. Service engineers are available if necessary to consult / carry out remedial work - Call helpline.

Cleaning. (Every one to two weeks depending on local water (hardness) conditions)

All glass panels in this product have a hydrophobic coating which aids "runoff" of water droplets, reducing the need for frequent cleaning however for best appearance & product life regular cleaning is recommended.

Use ONLY mild soap / detergent solutions to clean, rinse with water, squeegee glass panels and wipe frames dry with a soft cloth. Under no circumstances should abrasive, caustic or scouring products be used. Non-compliance with these cleaning instructions may cause decorative finishes to deteriorate & could adversely affect safe operation of the enclosure.

Daily Care.

To prevent the build up of limescale, do not allow water droplets to dry on glass or frames. After showering, rinse with water, remove droplets of water from glass with a squeegee & wipe frame with a soft cloth.

Customer Service.

Quality guarantee : We guarantee shower doors, enclosures and bathscreens against any manufacturing or material defects for the duration of the warranty. We will resolve defects free of charge by repairing / replacing parts as we feel necessary. To be free of charge, service work must be carried out by approved agents.

Seals are considered "wear & tear" parts and as such are guaranteed for 12 months from purchase.

Not covered by this guarantee : Damage or defects that result from improper installation, improper use or lack of maintenance (including limescale buildup). Damage or defects that result from repairs / modifications undertaken by unauthorised persons. This guarantee is in addition to statutory and other legal rights.

What to do if anything goes wrong : Should the product not function correctly on initial use, firstly contact the installer to check that unit installation & commissioning are in accordance with these instructions. Should this not resolve difficulties or should performance decline, consult 'Troubleshooting' section of these instructions to see if simple home maintenance is needed. Alternatively our helpline staff can assist or arrange for a service engineer to visit if necessary.

Spares : We maintain an extensive spare parts stocks. spares can be ordered / purchased from your retailer in the first instance. Parts will normally be despatched within two working days from placement of order.

A

Bathtub rims can vary greatly. for best results position wall profile such that the screen is toward the inside of the bath rim (inside highest point of rim)

With screw channel to the inside, ensure profile is fully plumb & mark centre of the 3 slots in the wall profile.

Drill marked positions with 6mm masonry / tile bit and plug holes.

Fix wall profile using 4mm x 35mm long screws (x3)

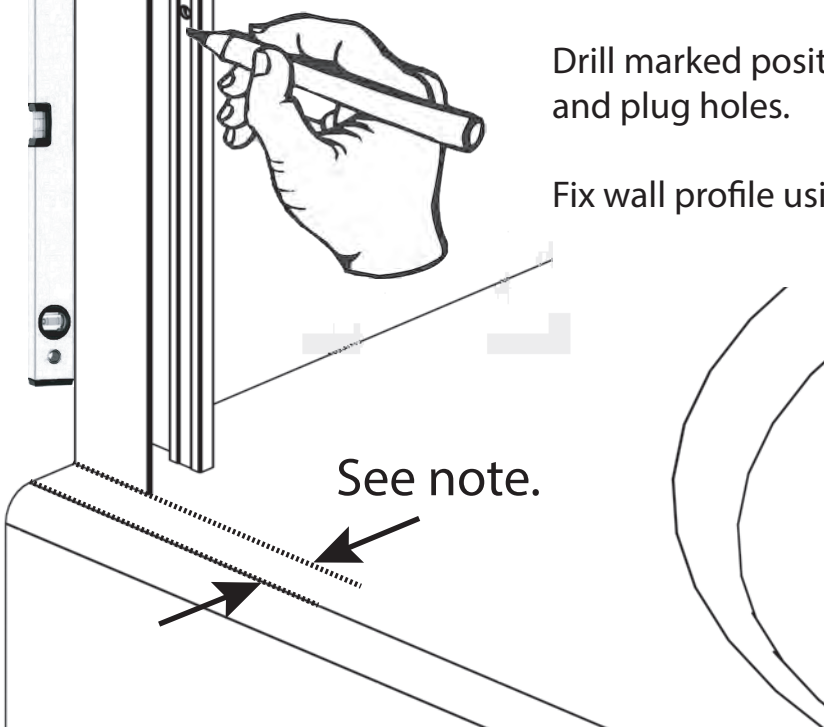

B

1. Fit glass support near to end of bathscreen panel.
2. Locate panel sub assembly fully into wall profile.

1.

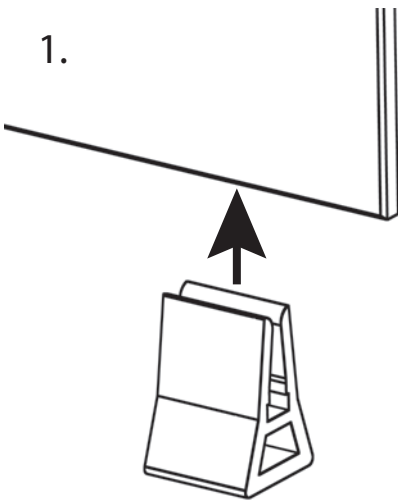

3. From inside of bathscreen, using wall profile holes as a guide, drill (\varnothing 3mm) & fix bathscreen to wall profile using 3.5mm x 8mm screws. Remove glass support

2.

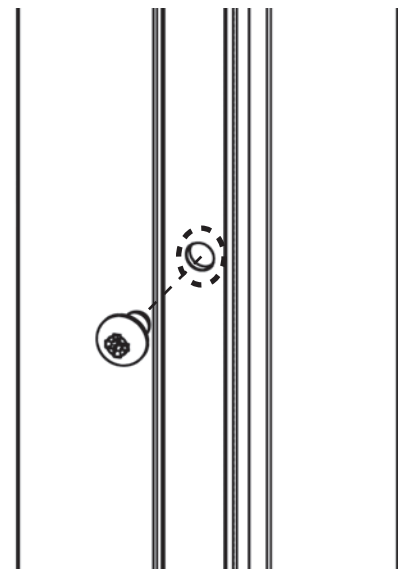
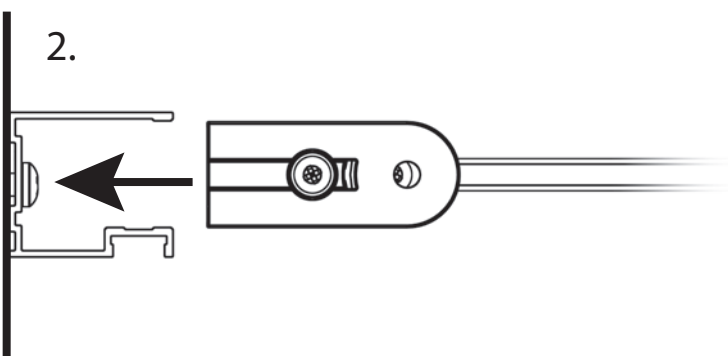

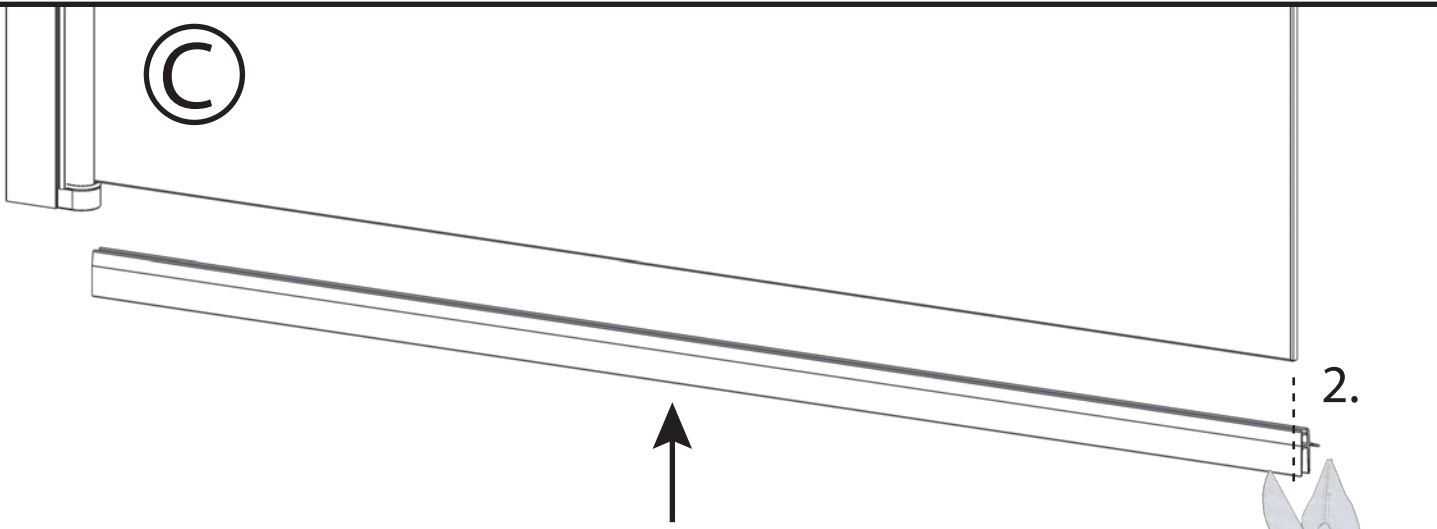

1. With drip lit to inside of unit, offer bottom seal onto bottom of hinged panel ensuring it butts fully up to hinge bracket, mark at end of glass panel & cut with seal snips.

2. Fit bottom seal, seal may be 'wetted' to aid fitment.

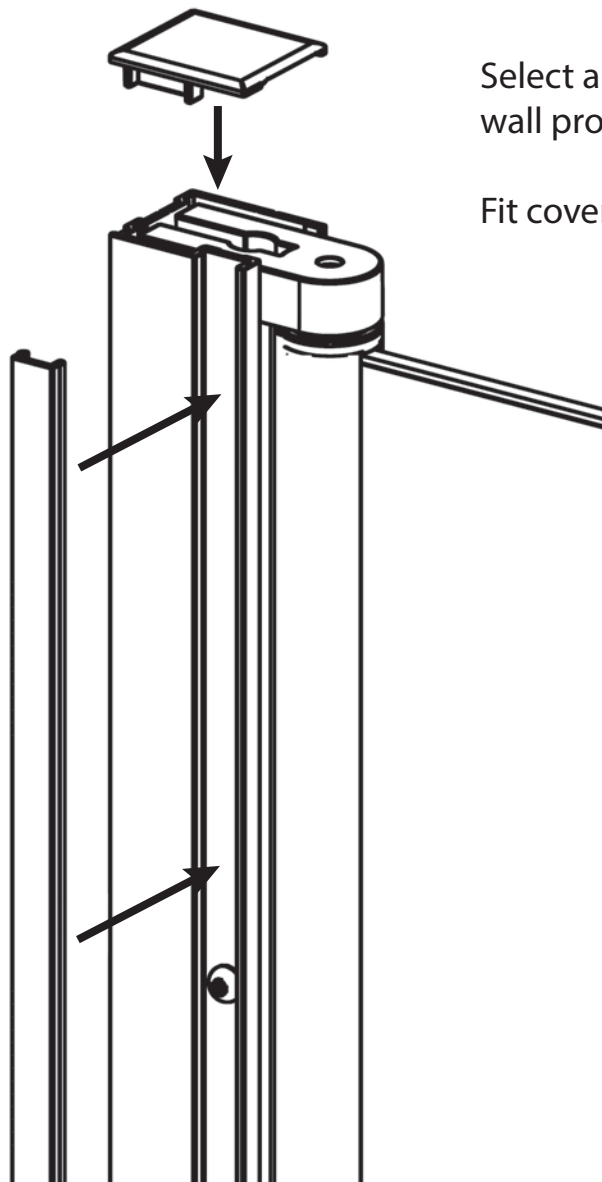

Select appropriate top cap (left / right) & fit to top of wall profile.

Fit cover strip into screw channel.

D

Sealing:

Use of good quality silicone sealant & cleaning / degreasing of all joint areas is recommended.

Apply continuous silicone sealant bead EXTERNALLY ONLY as shown.

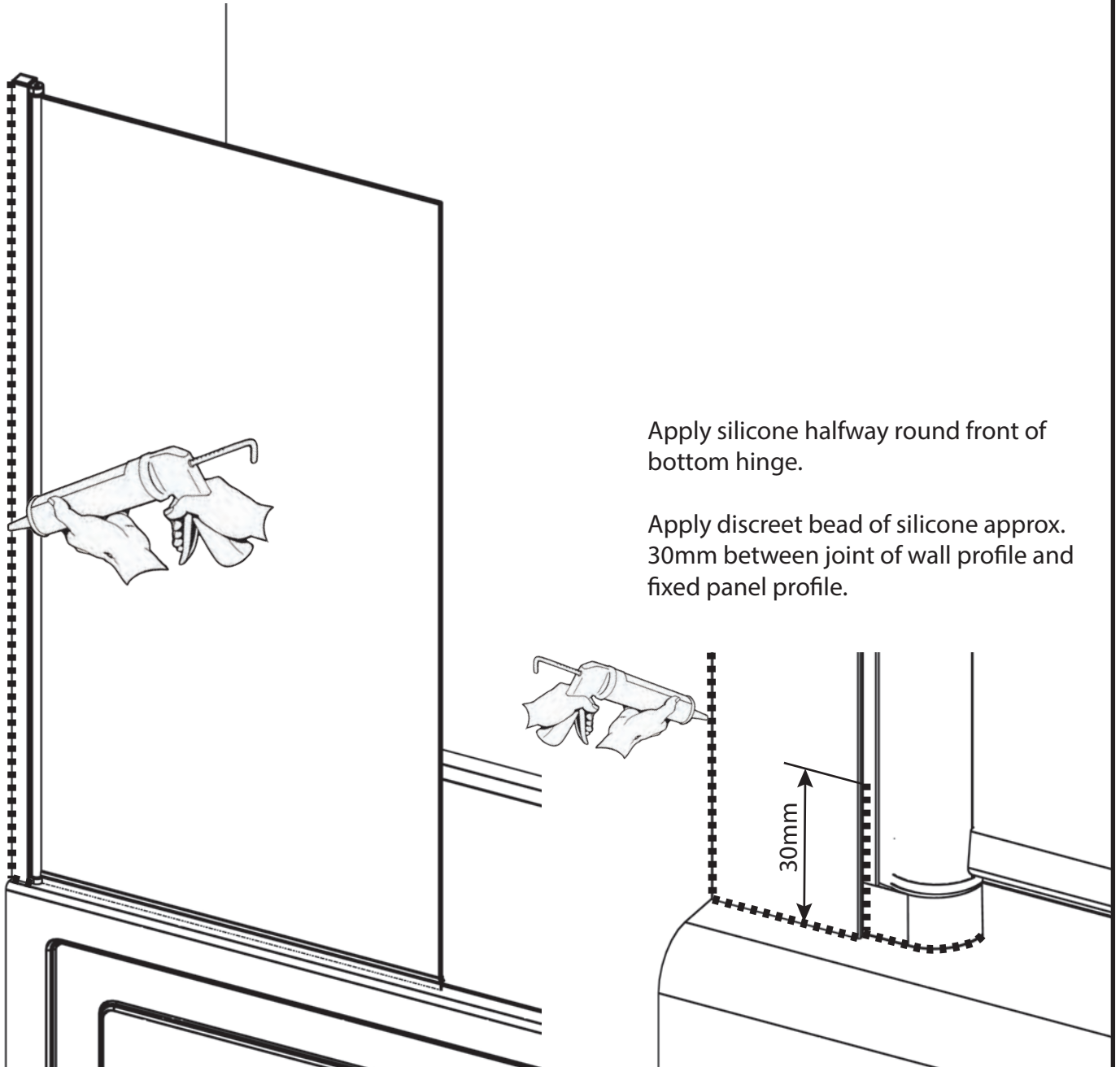

Apply silicone halfway round front of bottom hinge.

Apply discreet bead of silicone approx. 30mm between joint of wall profile and fixed panel profile.

Trouble shooting - Leakage :

The sealing method described in these instructions relies on a continuous seal being applied between shower walls & bathtub before installing the bathscreen, it ensures a watertight seal around the perimeter of the bathscreen to the shower walls & bathtub.

In the unlikely event of an enclosure leak, water will be visible on the outside of the enclosure itself, or around the perimeter silicone seal ONLY. Water / moisture appearing outside this area (i.e. at floor level) is normally due to incorrect bathtub installation.