

BIFOLD DOOR Installation & Maintenance Instructions

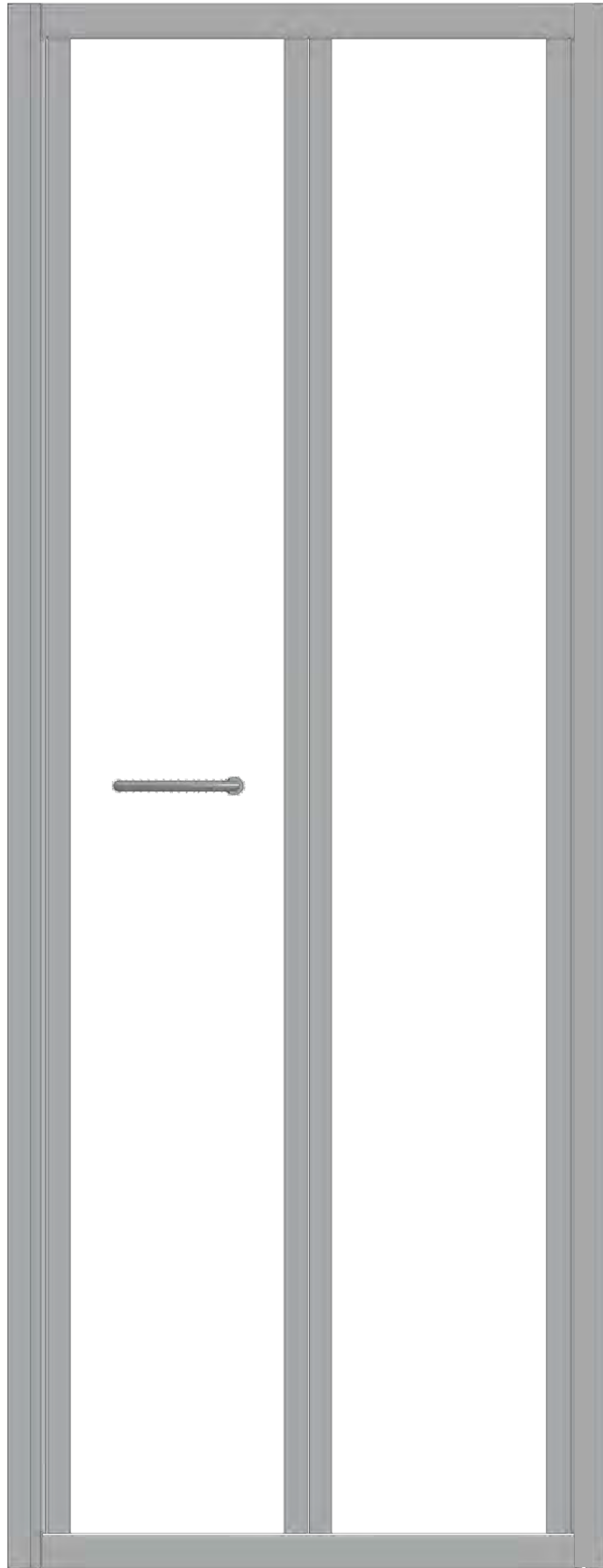

Important Notes :

Please Read Carefully & retain these instructions for Future Reference.

1. For ease & safety we advise that two persons assemble this product.
2. Protect shower tray surfaces at all times.
3. Check for cables, pipes etc before drilling walls.
4. Ensure all surfaces are dry, clean & free of loose debris / dust.
5. Unpack goods with care (small parts can become lodged in packaging & inadvertently discarded). Check parts supplied against parts & fittings listed herein. Damaged parts / omissions may be resolved by calling Helpline.
6. Whilst precautions are taken in manufacture, care must be taken when handling as rail ends may have sharp edges.
7. Before commencing, check :
 - a) shower tray is level & completely sealed to finished / tiled walls.
 - b) finished walls are sound & free of cracks loose tiles / grout.
8. AFTER INSTALLATION, DO NOT 'WET' ENCLOSURE FOR 48 HOURS TO ENSURE FULL CURE OF SILICONE SEALANT.

Use :

General Care & Maintenance.

Provided this product is installed & operated in accordance with these instructions, problems should not arise. However should maintenance be required it should be carried out by a competent person with reference to these instructions. Before any work is carried out the root cause of the problem must be identified. Service engineers are available to consult / carry out remedial work ~ call Helpline.

Cleaning.

(Every one to two weeks depending on local water {hardness} conditions).

All glass panels in this product have a hydrophobic coating aiding 'runoff' of water droplets, reducing the need for frequent cleaning. For best appearance / product life however, regular cleaning is recommended.

Use ONLY mild soap / detergent solutions to clean. Rinse with water, squeegee glass panels & wipe frames dry with a soft cloth. Under no circumstances should abrasive, caustic or scouring products be used. DO NOT use 'spray & leave' type cleaning products. Non compliance with these cleaning instructions may cause plated / painted finishes to deteriorate & could adversely affect safe operation of the enclosure.

Limescale ~ should a build up of limescale occur, remove using a 50:50 solution of white vinegar & water applied with a soft cloth & rinsed / dried thoroughly afterwards.

Daily Care.

To prevent the build up of limescale, do not allow water droplets to dry on glass or frames. After showering, rinse with water, remove droplets from glass with a squeegee & wipe frame with a soft cloth.

Customer Service.

Quality Guarantee : Shower Doors & Enclosures are guaranteed against any manufacturing or material defects for the duration of the warranty. Defects will be resolved free of charge by repairing or replacing parts as we feel necessary. To be 'free of charge' service work must be carried out by approved agents. Call Helpline.

Not Covered by this Guarantee : Damage or defects that result from improper installation, improper use, or lack of maintenance (including limescale buildup). Damage or defects that result from repairs or modifications undertaken by unauthorized persons.

This guarantee is in addition to statutory & other legal rights.

What to do if something goes wrong : Should the product not function correctly on initial use, firstly, contact the installer to check that unit installation & commissioning are in accordance with these instructions. Should this not resolve difficulties or should performance decline, consult 'Troubleshooting' section to see if simple home maintenance is needed.

Alternatively our Helpline staff can assist, or if necessary arrange for a service engineer to visit.

Spares : We maintain extensive spare part stocks. Spares can be ordered / purchased from your retailer in the first instance. Parts will normally be dispatched within two working days from order placement.

Pro Forma invoices will be sent for cheque payments.

Supplied Parts :

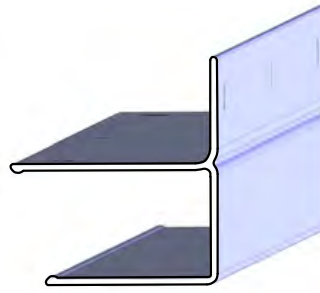
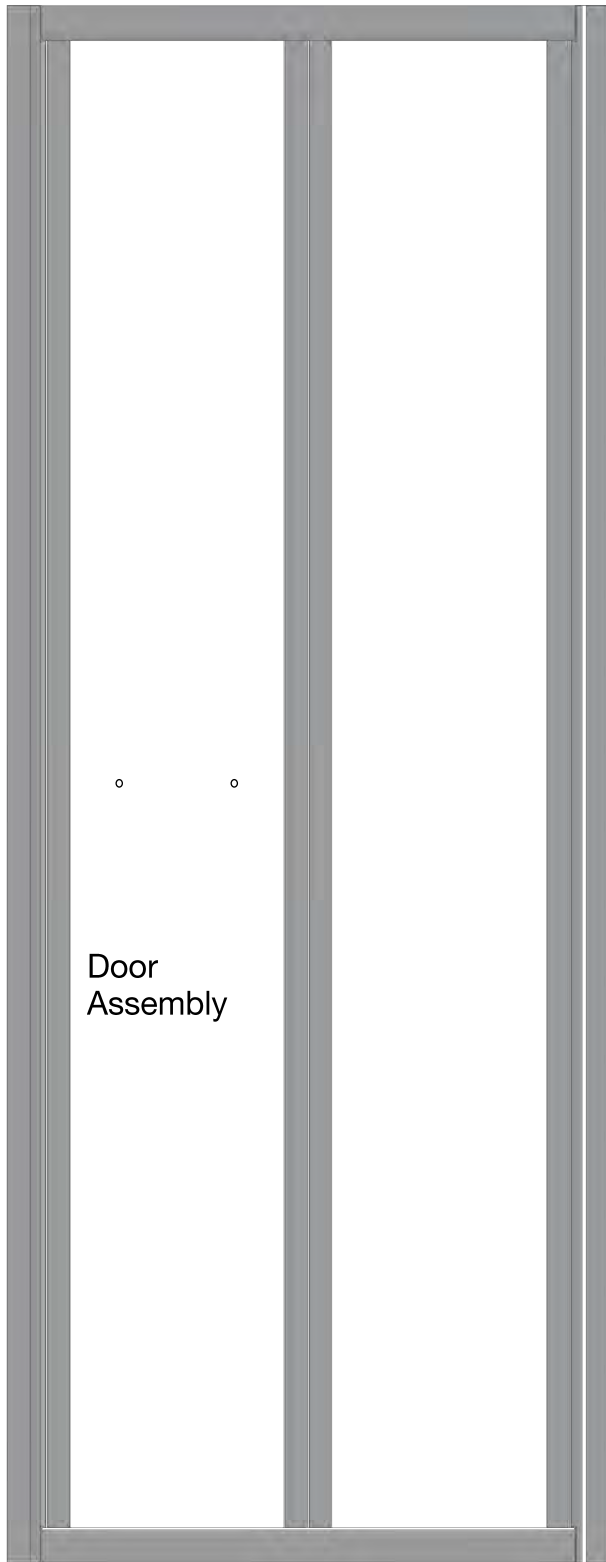

Wall Profile (1900mm)
2x

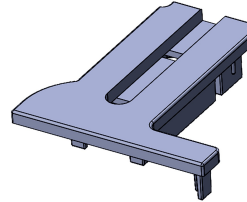

Top Cap - vert frames
(handed pair)

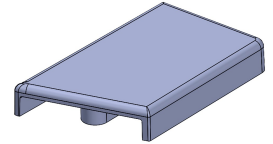

Top Cap - wall profiles
(handed pair)



Door Handle Kit

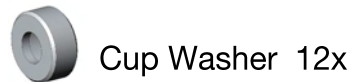
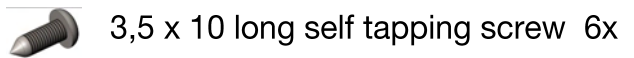
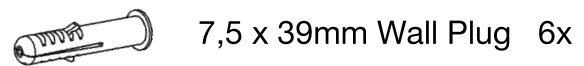
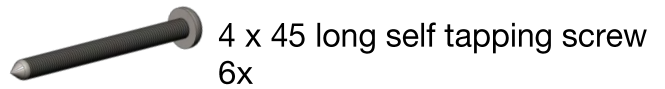

Tools Required

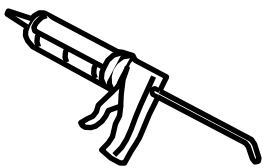

Good quality silicone
sealant & applicator

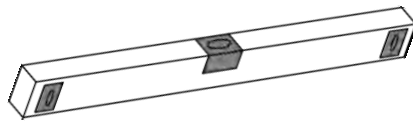

Spirit Level (with vertical 'bubble')

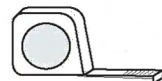

Tape Measure



Pencil



Pozi drive
Screwdriver



3mm HSS
drill bit



Power drill &
8mm masonry bit

Standard Sizes	Adjustment Range (Dim'n A)
700mm	650 - 690mm
750mm	700 - 740mm
800mm	750 - 790mm
900mm	850 - 890mm
1000mm	950 - 990mm

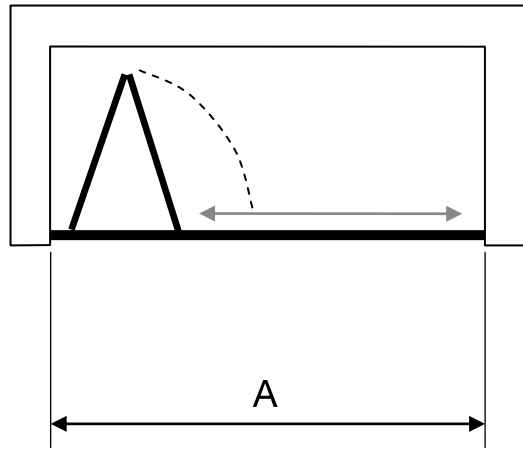

Bifold Door is fully reversible, so is suitable for fitting with door to left or right hand side of enclosure. Ensure tray is correctly levelled & that tray / wall (tile) joints are sealed & cured over entire length of tray sides (See Fig A) prior to fitting enclosure.
DO NOT SEAL TRAY EDGES UPTO A FITTED ENCLOSURE !

(A)

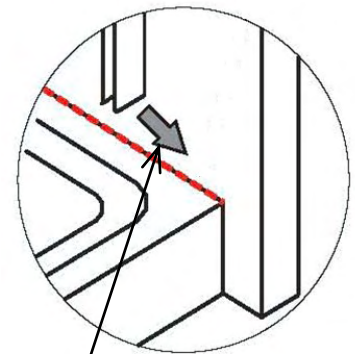
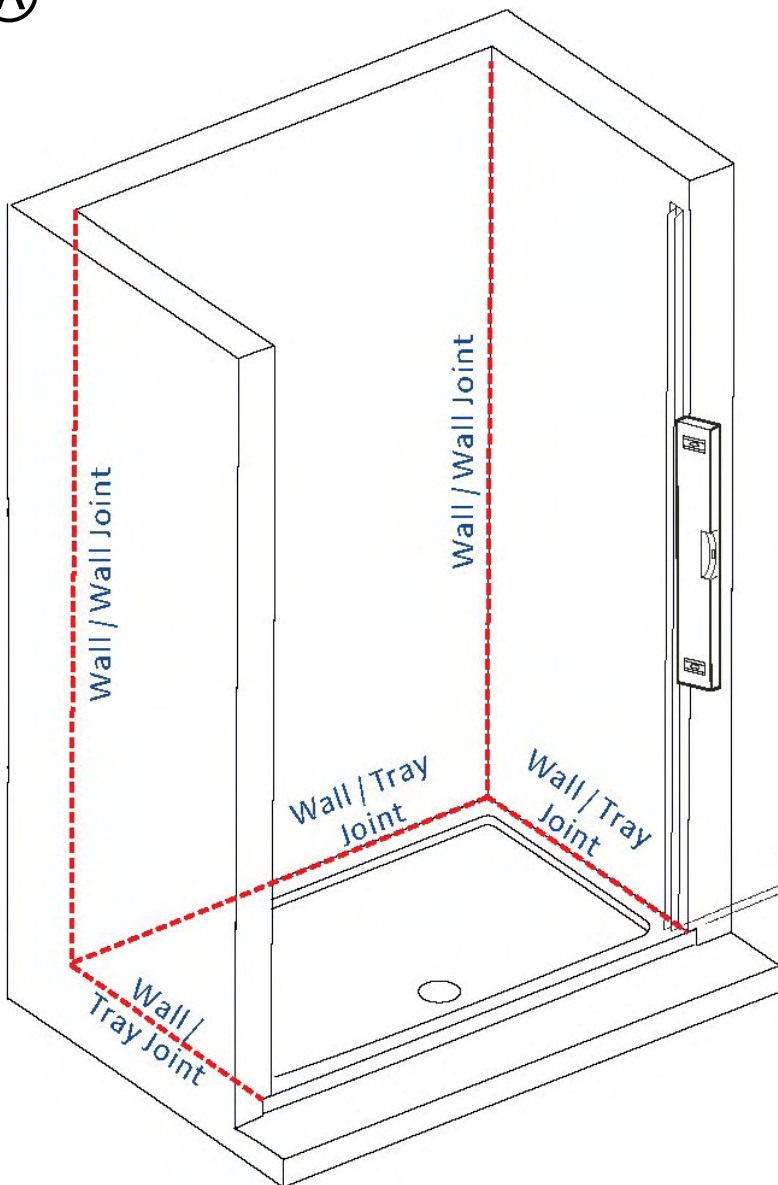

Ensure continuous silicone sealant bead before fitting wall rails

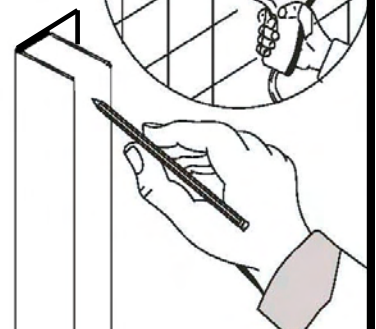
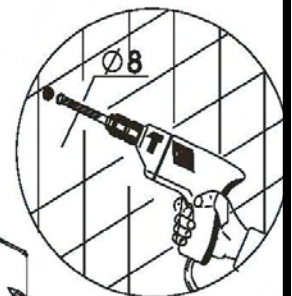

Wall profile orientation : Flange to shower side. Measure & mark wall rail positions. Mark fixing hole positions. Having decided required handing, **FIT DOOR SIDE WALL RAIL ONLY AT THIS STAGE.**

Main Frame Setup :

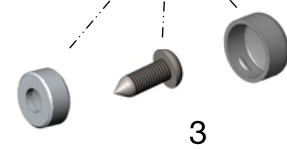
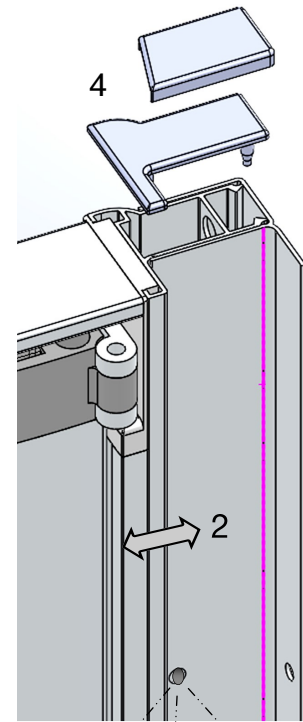
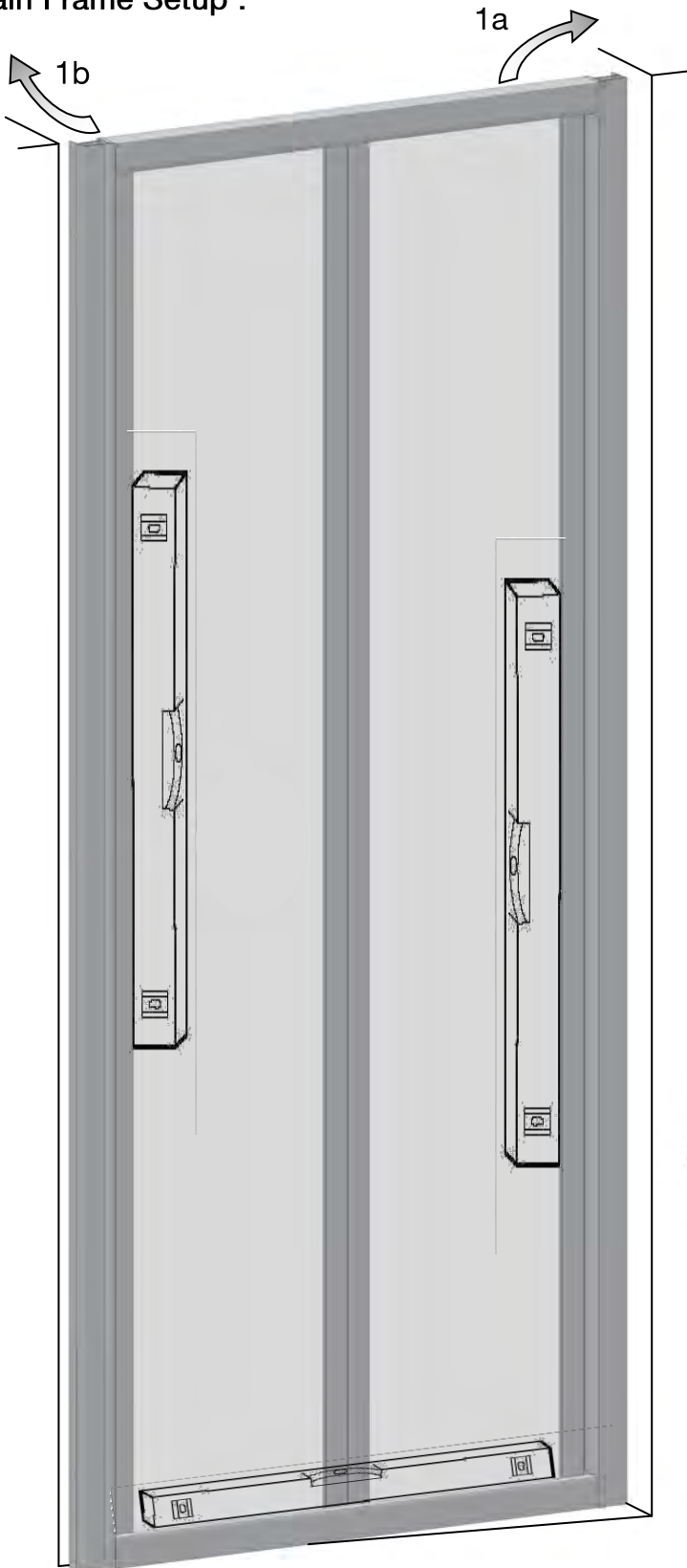

Fit door handle - ensure soft washers are fitted to either side of glass

1. Fit remaining wall rail fully onto hinge side of frame, lift door over tray & insert into fixed wall profile. Push hinge side back into alcove, align & fix panel side wall profile to wall with 4 x 45 long pan head screws, cup washers & caps.
2. Manipulate frame within wall profiles, until frame is plumb & door is centred in frame. Ensure gap between door glass & bottom rail is parallel.
3. From inside enclosure, using the wall profile holes as a guide, drill (3mm) & using cup washers & decorative caps, screw frame to wall profiles (6 places).
4. Fit door handle, & top caps to vertical frames / wall profiles.

(B)

Sealing :

©

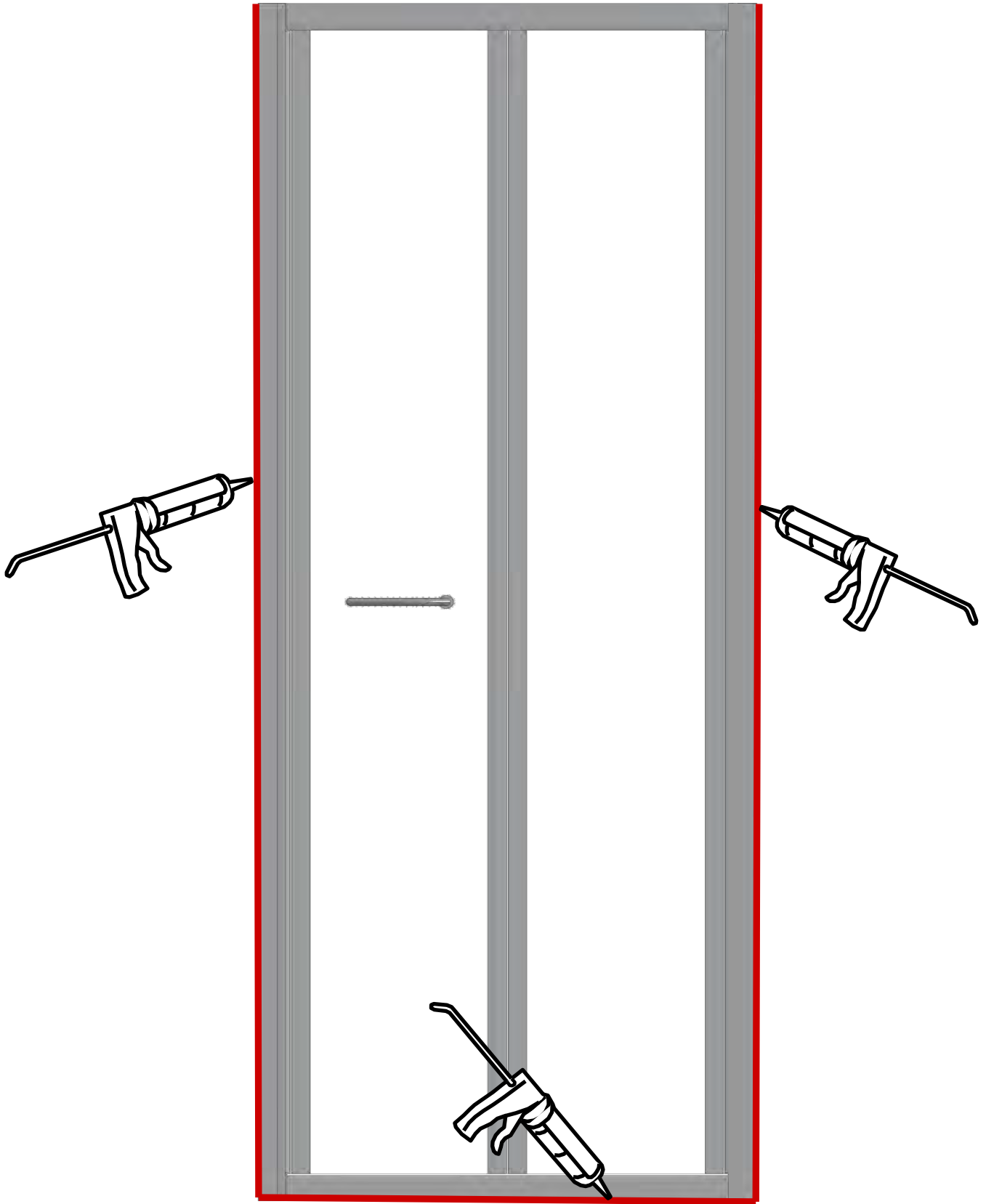

Use of good quality silicone sealant & cleaning / degreasing of all joint areas is recommended.
Apply continuous silicone sealant bead as indicated EXTERNALLY ONLY

Basic Troubleshooting :

Door latch not holding door closed :

Check alignment of door pegs with latch, if necessary loosen latch screws, close door to reset latch position, then carefully open door without disturbing latch position & re tighten screws.

Door motion noisy / Door not running smoothly :

Check that wheels are correctly engaged on tracks & check plumb/level of frame & door alignment, adjust frame if necessary (see fig B).

Door wheels & tracks are factory greased, however over time this may disperse or become contaminated by dust etc, cleaning of tracks & re application of sanitary silicone based grease will restore & ensure smooth door motion.

Leakage :

The sealing method described in these instructions relies on a continuous seal being applied between shower walls & tray before installing the enclosure (see fig A), it ensures a watertight seal around the perimeter of the enclosure to the shower walls & tray.

In the unlikely event of an enclosure leak, water will be visible on the outside of the enclosure itself, or around the perimeter silicone seal ONLY. Water / moisture appearing outside this area (ie at floor level) is normally due to incorrect tray installation.