

# FRAMED (Folding) BATHSCREENS

## Installation & Maintenance Instructions

rev 01.19

Models Covered :

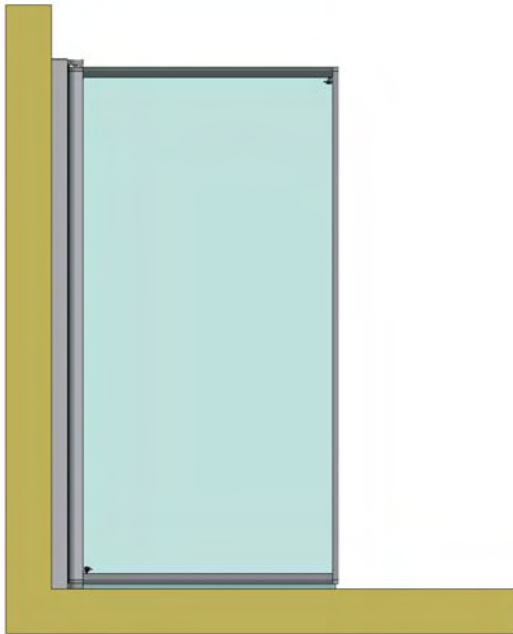

SS70 ~ SINGLE PANEL

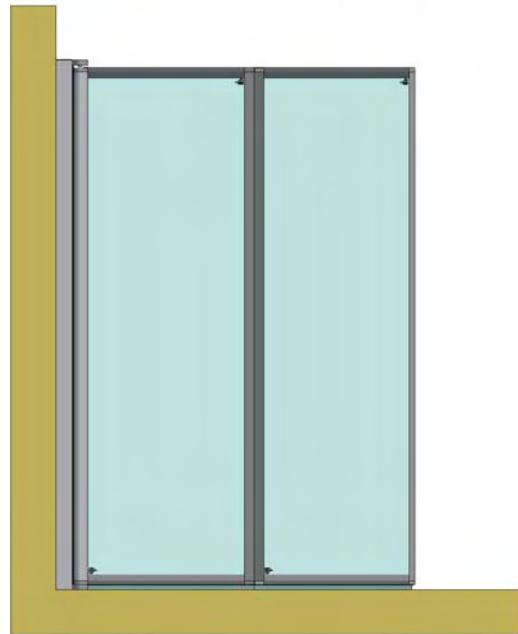

SS75 ~ TWIN PANEL

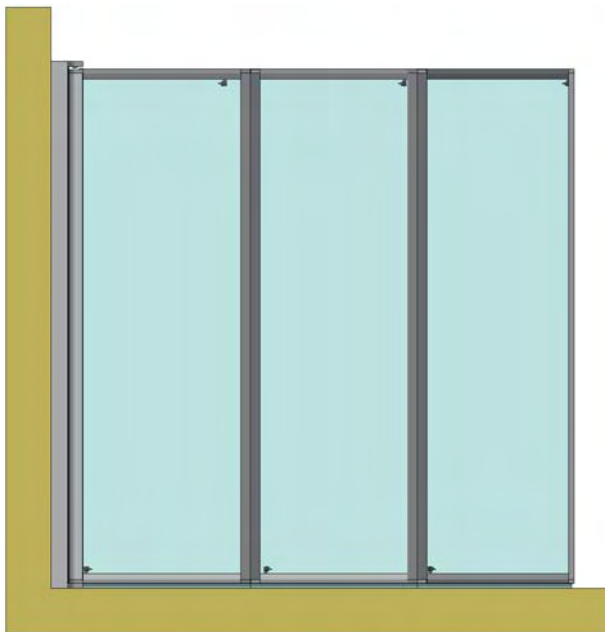

SS80 ~ TRIPLE PANEL

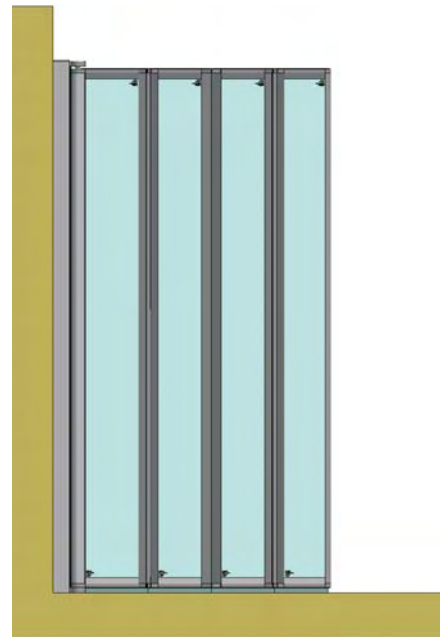

SS85 ~ FOUR PANEL



**LAKES**  
SHOWERING SPACES

## IMPORTANT NOTES :

Please Read Carefully & retain these instructions for Future Reference.

1. For ease & safety we advise that two persons assemble this product.
2. Protect shower tray surfaces at all times.
3. Exposed glass corners / edges MUST NOT contact hard surfaces at any time.
4. Check for cables, pipes etc before drilling walls.
5. Ensure all surfaces are dry, clean & free of loose debris / dust.
6. Unpack goods with care (small parts can become lodged in packaging & inadvertently discarded). Check parts supplied against parts & fittings listed herein. Damaged parts / omissions may be resolved by calling Lakes Bathrooms Helpline.
7. Whilst precautions are taken in manufacture, care must be taken when handling as rail ends may have sharp edges.
8. Before commencing, check :
  - a) shower tray (or base) is level & completely sealed to finished / tiled walls.
  - b) finished walls are sound & free of cracks, loose tiles / grout.
8. AFTER INSTALLATION, DO NOT 'WET' ENCLOSURE FOR 48 HOURS TO ENSURE FULL CURE OF SILICONE SEALANT.

## USE :

### General Care & Maintenance.

Provided this product is installed & operated in accordance with these instructions, problems should not arise. However should maintenance be required it should be carried out by a competent person with reference to these instructions. Before any work is carried out the root cause of the problem must be identified. Lakes Bathrooms service engineers are available if necessary to consult / carry out remedial work. Call Lakes Bathrooms HELPLINE.

### Cleaning.

(Every one to two weeks depending on local water {hardness} conditions).

All glass panels in this product have a hydrophobic coating aiding 'runoff' of water droplets, reducing the need for frequent cleaning. For best appearance / product life however, regular cleaning is recommended.

Use ONLY mild soap / detergent solutions to clean. Rinse with water, squeegee glass panels & wipe frames dry with a soft cloth. Under no circumstances should abrasive, caustic or scouring products be used. Non compliance with these cleaning instructions may cause decorative finishes to deteriorate & could adversely affect safe operation of the enclosure.

### Daily Care.

To prevent the build up of limescale, do not allow water droplets to dry on glass or frames. After showering, rinse with water, remove droplets from glass with a squeegee & wipe frame with a soft cloth.

### Customer Service.

Quality Guarantee : Lakes Bathrooms Ltd guarantee Shower Doors & Enclosures against any manufacturing or material defects for the lifetime of the product. We will resolve defects free of charge by repairing / replacing parts as we feel necessary. To be 'free of charge' service work must be carried out by Lakes Bathrooms or approved agents.

Seals are considered 'wear & tear' parts, as such they are guaranteed for 12 months from purchase. Not Covered by this Guarantee : Damage or defects that result from improper installation, improper use, or lack of maintenance (including limescale buildup). Damage or defects that result from repairs / modifications undertaken by unauthorized persons. This guarantee is in addition to statutory & other legal rights.

What to do if something goes wrong : Should the product not function correctly on initial use, firstly, contact the installer to check that unit installation & commissioning are in accordance with these instructions. Should this not resolve difficulties or should performance decline, consult 'Troubleshooting' section to see if simple home maintenance is needed. Alternatively our HELPLINE staff can assist, or if necessary arrange for a service engineer to visit.

Spares : We maintain extensive spare part stocks. Spares can be ordered / purchased from your retailer in the first instance. Parts will normally be dispatched within two working days from order placement.

**SUPPLIED PARTS :**

**Screen Sub Assembly:**

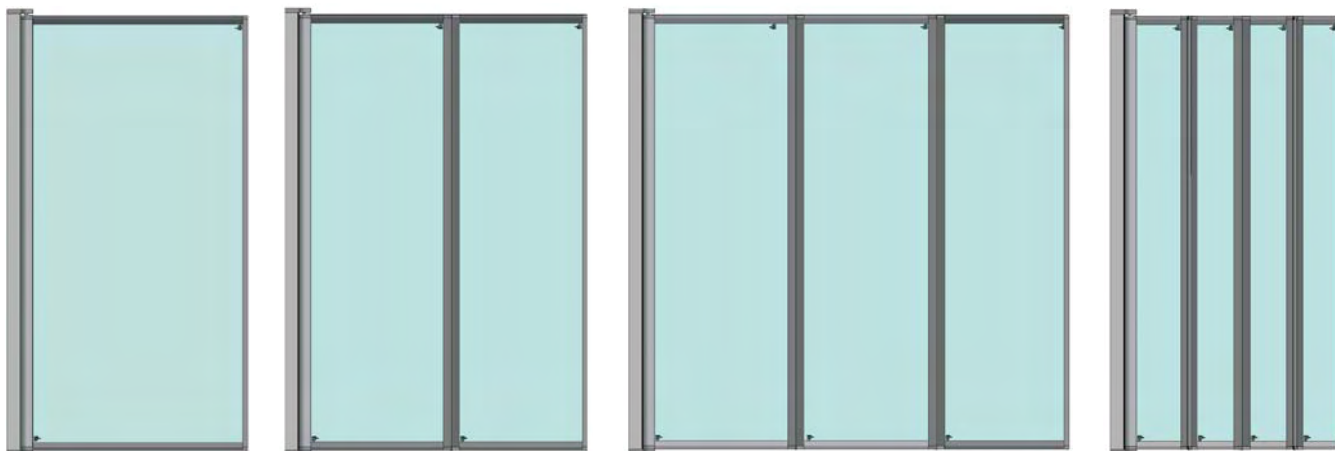

Single Panel

Or

Twin Panel

Or

Triple Panel

Or

Four Panel

**Comprising (replaceable parts) :**

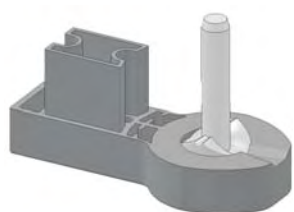

Wall Hinge (2x)



Hinge Half (Male)



Hinge Rail (Wall side)



Hinge Bearing (2x)



Hinge Half (Female)

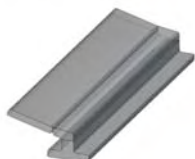

Hinge Seal (2x)



Corner Piece (2x)



M3,5 x 40 long Pan Head Pozi Drive Screw

&

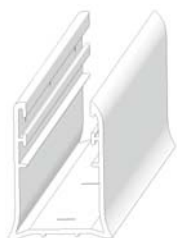

Wall Rail fig A



5mm x 60 long Countersunk Self Tapping Screw (3x) fig A



Top Cap (2x) (Wall Profile) (handed pair) fig B

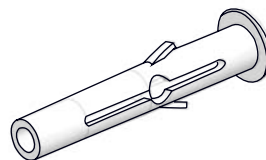

8 x 50mm Wall Plug (3x) fig A



3.5 x 10 long self tapping pan head screw (3x) fig B



Bottom Seal (set) fig B



Top Capping (set) fig B



Cup Washer (3x) fig B



Decorative Screw Cover Cap (3x) fig B

Standard Size	Adjustment (A)
SS70	760 to 785mm
SS75	950 to 975mm
SS80	1390 to 1415mm
SS85	730 to 755mm

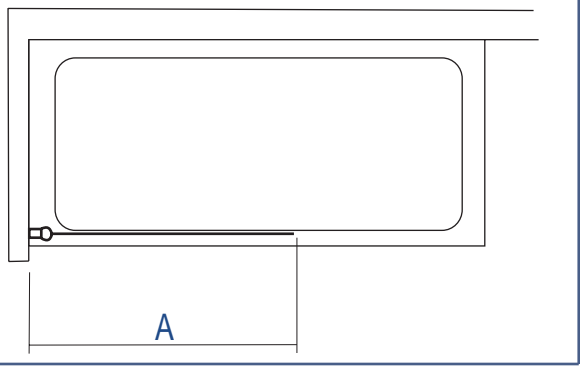

### Tools Required

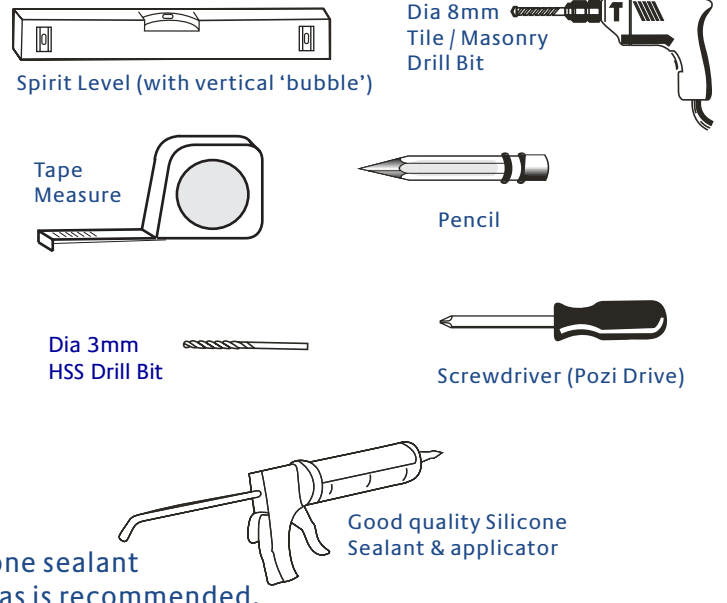

The use of good quality silicone sealant & cleaning / degreasing of all joint areas is recommended.

Lakes fully reversible Framed (folding) Bathscreen for fitting left or right handed to flat top bathtub.

Ensure bath rim is level & that bath / wall (tile) joints are sealed & cured over entire length of bath sides (See Fig A) prior to fitting screen.

**DO NOT SEAL BATH EDGES UPTO A FITTED SCREEN !**

**A**

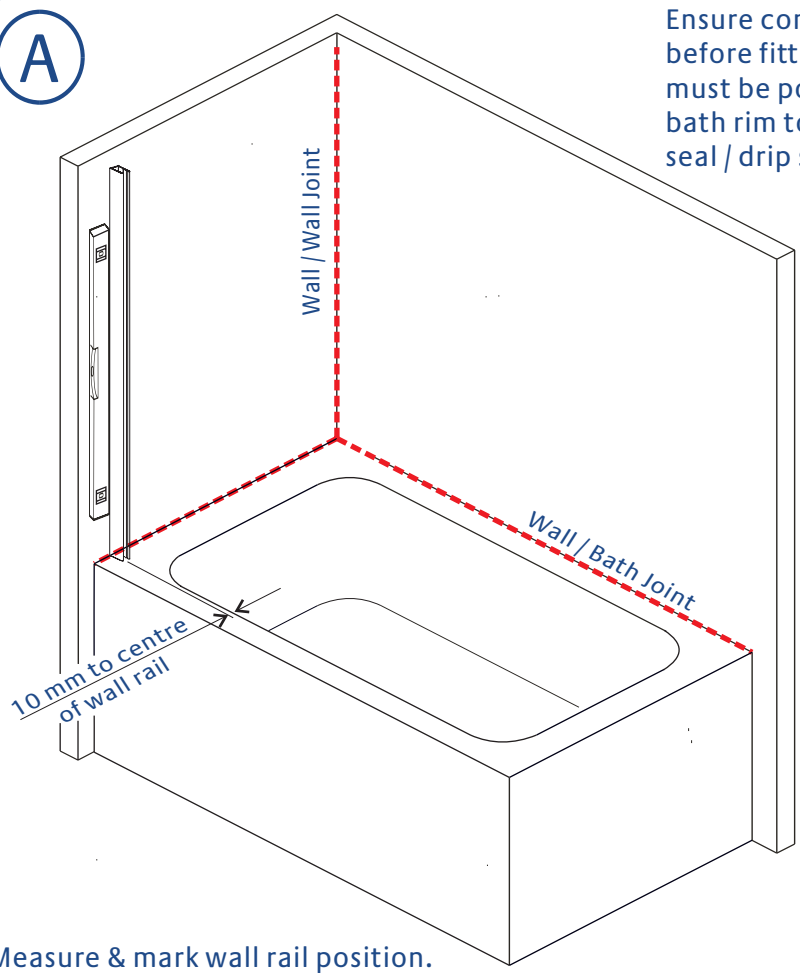

Ensure continuous silicone sealant bead as indicated before fitting wall rail. For best performance, screen must be positioned adjacent to the inner edge of the bath rim to ensure effectiveness of the bottom seal / drip strip.

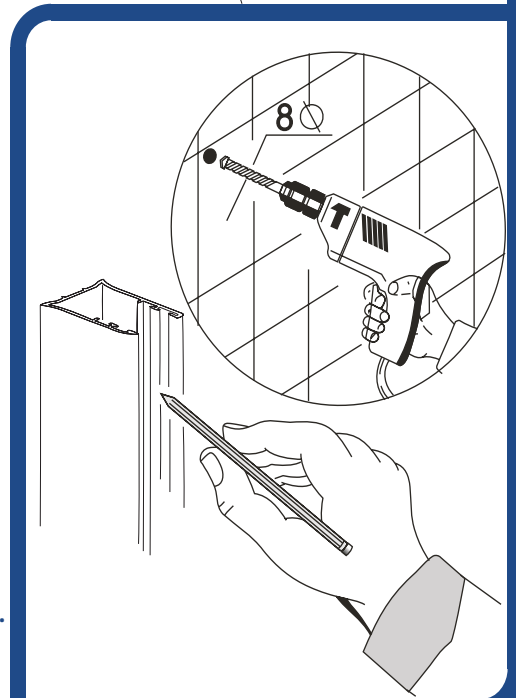
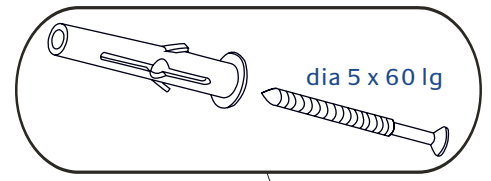

Measure & mark wall rail position.  
 Wall rail orientation : Cross holes to inside (curved face outermost).  
 Mark fixing hole positions, drill, plug & affix wall rail.  
 (Back face of Wall profile may be siliconed before mounting).

**B**

Multi panel screens can be folded flat to the mounting wall. Before fitting, the folding direction & storage hand should be determined by reversing the screen (top to bottom) for the preferred orientation.

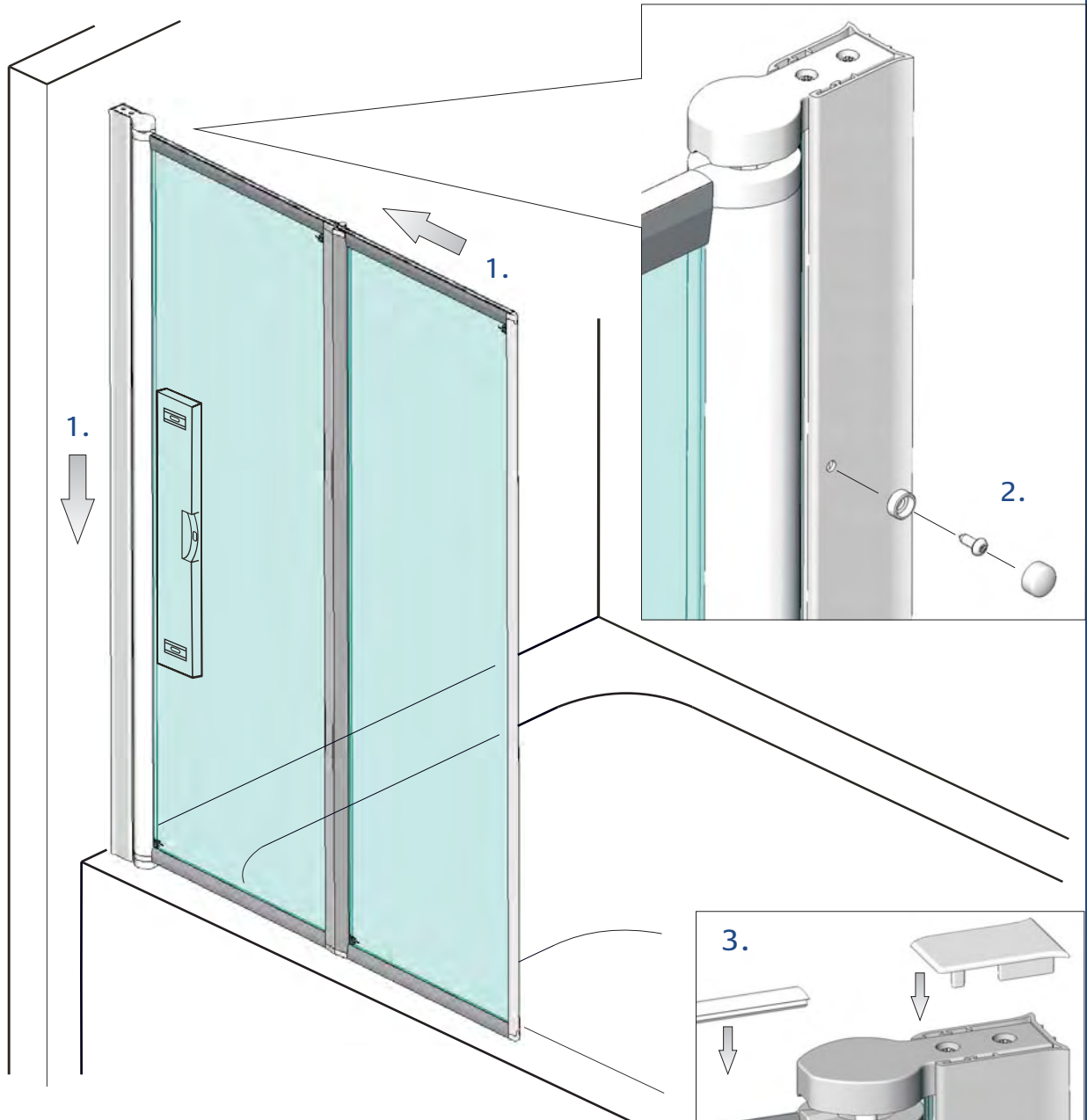

1. Carefully lift screen into position & push into wall profile. Check bottom hinge bracket is sitting on bath rim. Adjust screen for plumb & ensure even gap between screen base & bath rim (to accommodate bottom seals).

2. From inside enclosure, using wall rail holes as a guide, drill (dia 3mm) fit cup washer & screw main screen to wall rail using 3,5 x 10 long pan head screws. Push on decorative cover caps (3 places).

3. Fit top capping(s). Select & fit appropriate hand wall rail top cap.

4. Move screen to convenient position, select appropriate bottom seals & fit with drip strips to inside. Check that 1st panel seal is pushed up to wall hinge & that subsequent seals are end to end with minimal gaps.

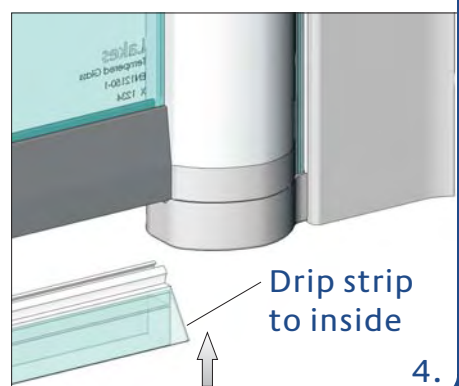
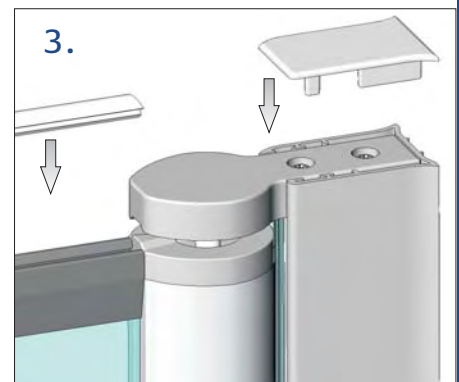

©

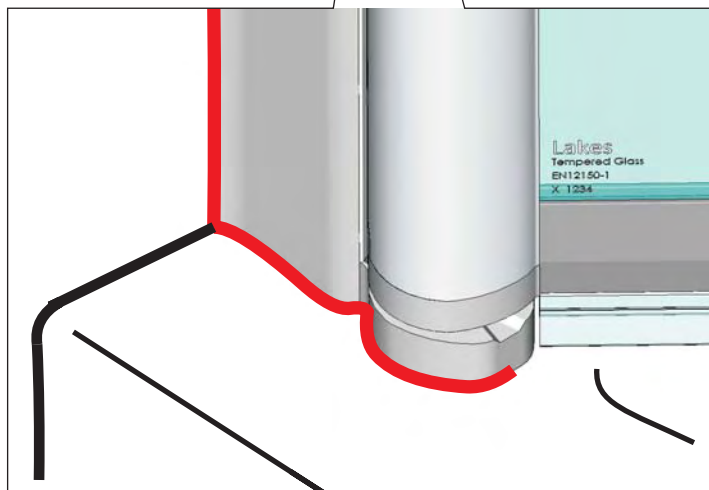
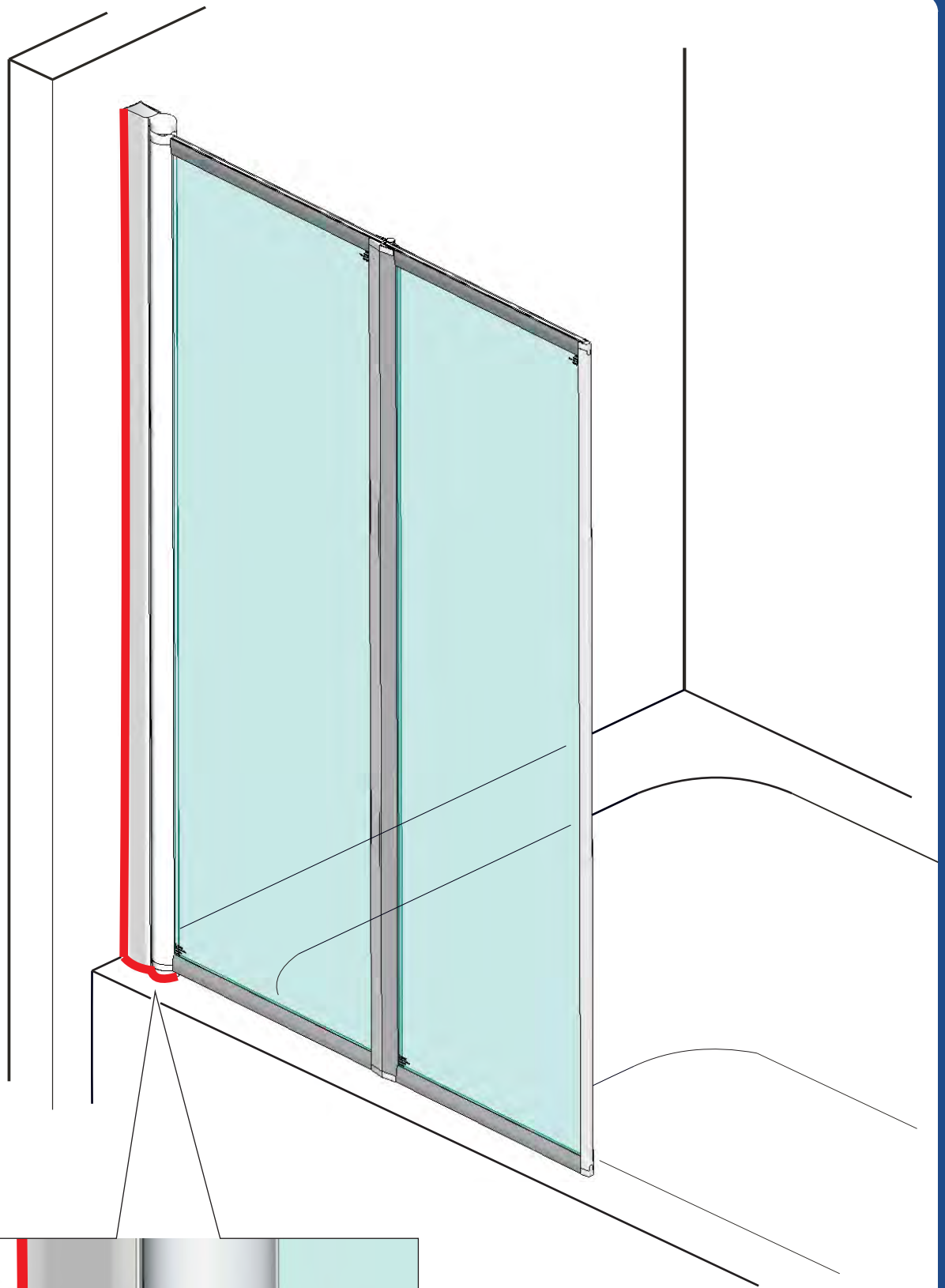

Check screen functions:  
Folds flat to wall & extends/locks to straight position (shown).  
Check that bottom seal(s) are in contact with bath rim over entire length.

Move screen inward over bathtub & apply continuous bead of silicone sealant as indicated EXTERNALLY ONLY.

## BASIC TROUBLESHOOTING :

Screen hinges noisy / not moving smoothly : Apply sanitary silicone based grease to hinge bearing inner diameters.

Check that hinge seals are not distorted or trapped in gap between profiles.

Leakage in area of bottom hinge : ensure bottom seal is pushed fully upto bottom hinge.

Water pooling on inside of screen : check 'fall' of bath rim is toward bathing area (certain bathtubs are unsuitable for screens of this type).

Check also, that screen is positioned adjacent to the inner edge of the bath rim.

### Leakage :

The sealing method described in these instructions relies on a continuous seal being applied between walls & bathtub before installing the screen (see fig A), it ensures a watertight seal around the perimeter of the bathtub to the walls.

In the unlikely event of a screen leak, water will be visible externally at the bottom of the screen or around the wall / bottom hinge ONLY. Water / moisture appearing outside this area (ie under the bathtub or at floor level) is normally due to incorrect bathtub installation / sealing.



Lakes Bathrooms Ltd

Alexandra Way

Ashchurch

Tewkesbury

Gloucestershire

GL20 8NB

Service : England, Scotland, Wales

8.30am—5pm Mon~ Thurs

8.30am—4.30pm Fri

Tel / HELPLINE : 01684 853870

Fax : 01684 857411

[www.lakesbathrooms.co.uk](http://www.lakesbathrooms.co.uk)

email : [admin@lakesbathrooms.co.uk](mailto:admin@lakesbathrooms.co.uk)

Service : Northern Ireland

Ian A Kernohan

Firtrees

Green Way Industrial Estate

Conlig

Northern Ireland

BT23 7SU

8.30am - 5pm Mon~Thurs

8.30am - 4.30pm Fri

Tel : 02891 270233

Fax : 02891 270597

Email : [info@iakonline.com](mailto:info@iakonline.com)