

SINGLE PANEL BATHSCREENS

Installation & Maintenance Instructions

Models Covered :

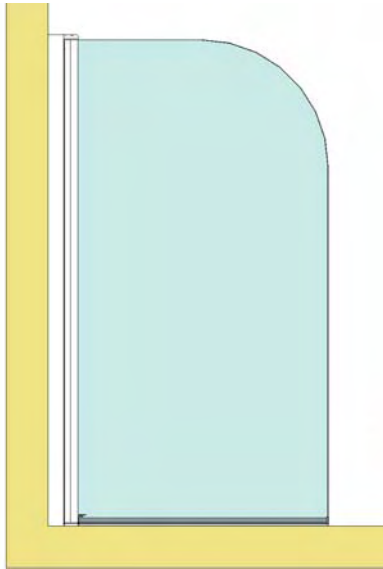

SS10 : CURVED SCREEN

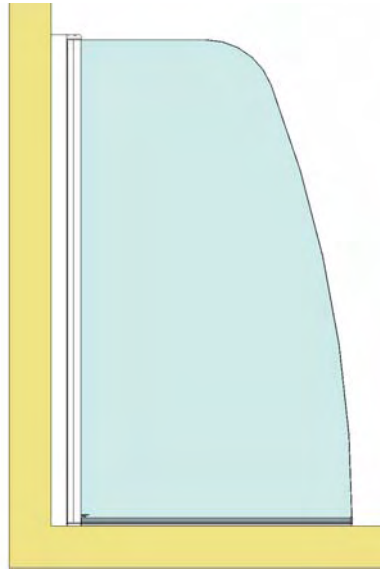

SS30 : SCULPTED SCREEN

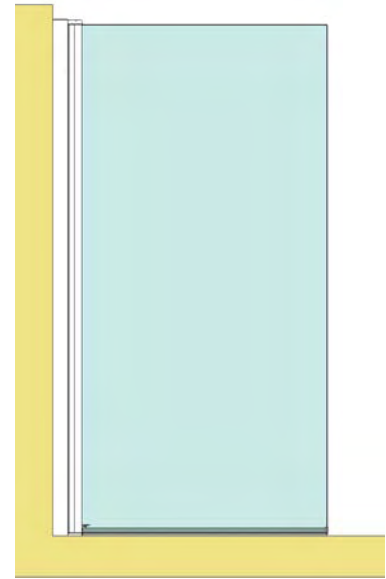

SS50 : SQUARE SCREEN

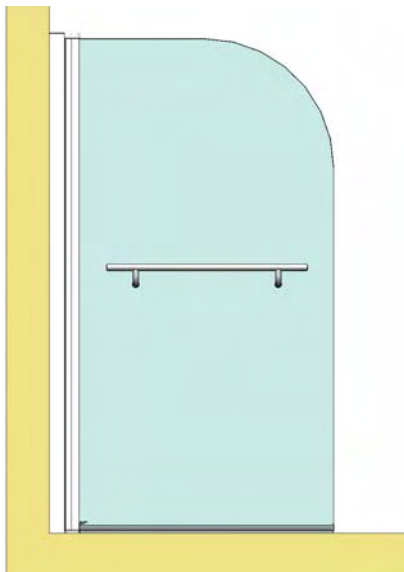

SS11 : CURVED SCREEN
+ TOWEL RAIL

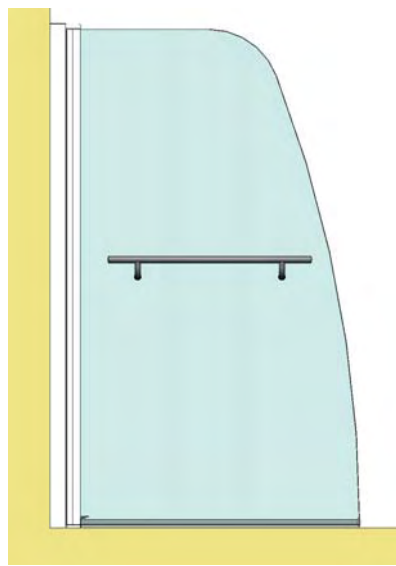

SS33 : SCULPTED SCREEN
+ TOWEL RAIL

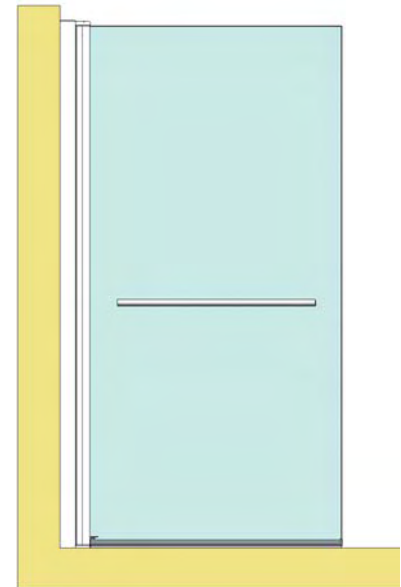

SS55 : SQUARE SCREEN
+ TOWEL RAIL



LAKES
SHOWERING SPACES

Rev 02.12

IMPORTANT NOTES :

Please Read Carefully & retain these instructions for Future Reference.

1. For ease & safety we advise that two persons assemble this product.
2. Protect shower tray surfaces at all times.
3. Exposed glass corners / edges MUST NOT contact hard surfaces at any time.
4. Check for cables, pipes etc before drilling walls.
5. Ensure all surfaces are dry, clean & free of loose debris / dust.
6. Unpack goods with care (small parts can become lodged in packaging & inadvertently discarded). Check parts supplied against parts & fittings listed herein. Damaged parts / omissions may be resolved by calling Lakes Bathrooms Helpline.
7. Whilst precautions are taken in manufacture, care must be taken when handling as rail ends may have sharp edges.
8. Before commencing, check :
 - a) shower tray (or base) is level & completely sealed to finished / tiled walls.
 - b) finished walls are sound & free of cracks, loose tiles / grout.
8. AFTER INSTALLATION, DO NOT 'WET' ENCLOSURE FOR 48 HOURS TO ENSURE FULL CURE OF SILICONE SEALANT.

USE :

General Care & Maintenance.

Provided this product is installed & operated in accordance with these instructions, problems should not arise. However should maintenance be required it should be carried out by a competent person with reference to these instructions. Before any work is carried out the root cause of the problem must be identified. Lakes Bathrooms service engineers are available if necessary to consult / carry out remedial work. Call Lakes Bathrooms HELPLINE.

Cleaning.

(Every one to two weeks depending on local water {hardness} conditions).

All glass panels in this product have a hydrophobic coating aiding 'runoff' of water droplets, reducing the need for frequent cleaning. For best appearance / product life however, regular cleaning is recommended.

Use ONLY mild soap / detergent solutions to clean. Rinse with water, squeegee glass panels & wipe frames dry with a soft cloth. Under no circumstances should abrasive, caustic or scouring products be used. Non compliance with these cleaning instructions may cause decorative finishes to deteriorate & could adversely affect safe operation of the enclosure.

Daily Care.

To prevent the build up of limescale, do not allow water droplets to dry on glass or frames. After showering, rinse with water, remove droplets from glass with a squeegee & wipe frame with a soft cloth.

Customer Service.

Quality Guarantee : Lakes Bathrooms Ltd guarantee Shower Doors & Enclosures against any manufacturing or material defects for the lifetime of the product. We will resolve defects free of charge by repairing / replacing parts as we feel necessary. To be 'free of charge' service work must be carried out by Lakes Bathrooms or approved agents.

Seals are considered 'wear & tear' parts, as such they are guaranteed for 12 months from purchase. Not Covered by this Guarantee : Damage or defects that result from improper installation, improper use, or lack of maintenance (including limescale buildup). Damage or defects that result from repairs / modifications undertaken by unauthorized persons. This guarantee is in addition to statutory & other legal rights.

What to do if something goes wrong : Should the product not function correctly on initial use, firstly, contact the installer to check that unit installation & commissioning are in accordance with these instructions. Should this not resolve difficulties or should performance decline, consult 'Troubleshooting' section to see if simple home maintenance is needed. Alternatively our HELPLINE staff can assist, or if necessary arrange for a service engineer to visit.

Spares : We maintain extensive spare part stocks. Spares can be ordered / purchased from your retailer in the first instance. Parts will normally be dispatched within two working days from order placement.

SUPPLIED PARTS :

Screen Sub Assembly
Comprising:

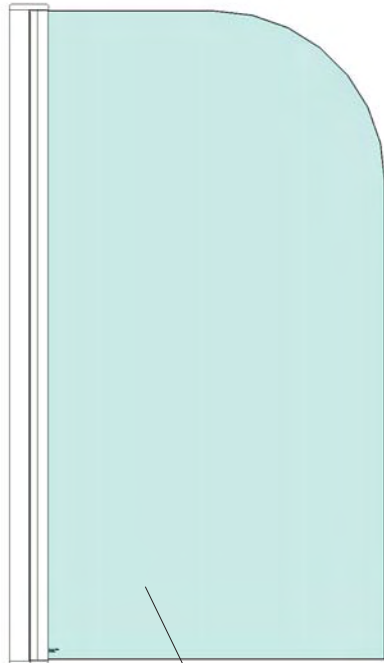

Screen Glass
(Curved shown)



Hinge Rail
(bonded to
screen glass)

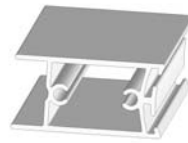

Hinge Rail
(Wall side)



Hinge Bearing
(2x)

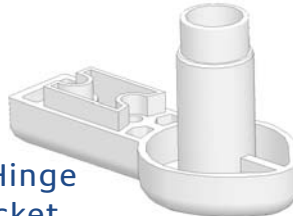

Top Hinge
Bracket

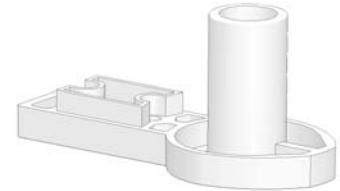

Bottom Hinge
Bracket

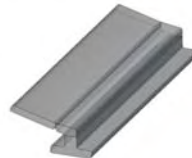

Hinge Seal
(2x)



M4 x 30 long Pan Head
Pozi Drive Screw (4x)

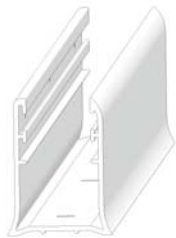

Wall Rail
fig A



5mm x 60 long Countersunk
Self Tapping Screw (3x) fig A

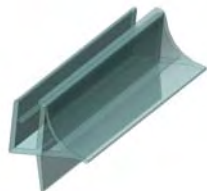

Bottom Seal
fig B2

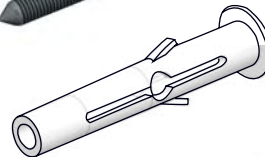

8 x 50mm Wall Plug
(3x) fig A



3.5 x 10 long self tapping
pan head screw (3x) fig B1



Cup Washer (3x) fig B1



Decorative Screw Cover
Cap (3x) fig B1



Outer End Cap (2x)
(bottom seal) fig B2
(handed pair)



Inner End Cap (2x)
(bottom seal) fig B2
(handed pair)



Towel Rail Kit
(SS11, SS33 & SS55 Only)
fig C

Assembly Aids fig B1



Top Cap (2x)
(Wall Profile)
(handed pair)
fig B1



Glass Support



1mm Basepad for
Glass Support

Standard Size	Adjustment (A)
SS10 / SS11	800 to 825mm
SS30 / SS33	860 to 885mm
SS50 / SS55	800 to 825mm

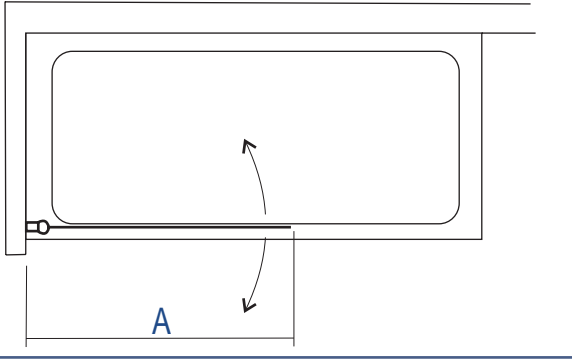

Tools Required

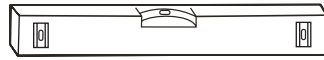

Spirit Level (with vertical 'bubble')



Tape Measure



Dia 3mm HSS Drill Bit



Dia 8mm Tile / Masonry Drill Bit



Pencil



Screwdriver (Pozi Drive)

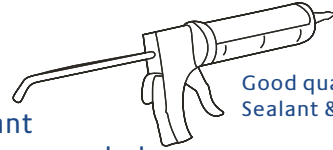

Good quality Silicone Sealant & applicator

The use of good quality silicone sealant & cleaning / degreasing of all joint areas is recommended.

Lakes fully reversible Single Panel Bathscreen for fitting left or right handed to suitable bathtub.

Ensure bath rim is level & that bath / wall (tile) joints are sealed & cured over entire length of bath sides (See Fig A) prior to fitting screen.

DO NOT SEAL BATH EDGES UPTO A FITTED SCREEN !

A

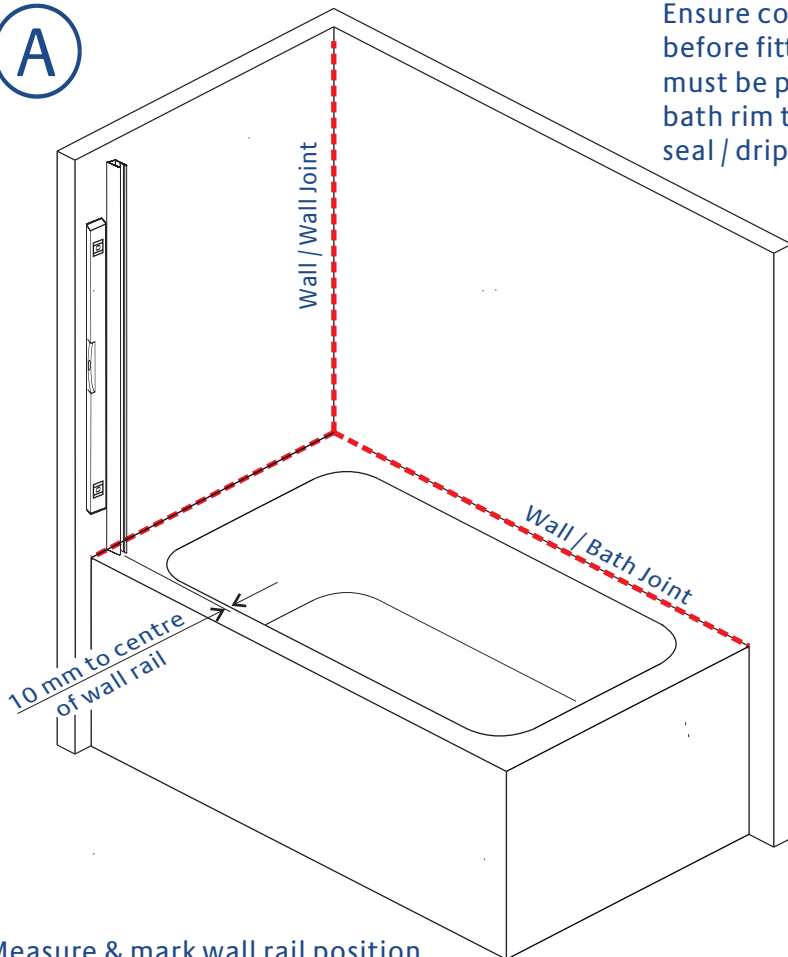

Ensure continuous silicone sealant bead as indicated before fitting wall rail. For best performance, screen must be positioned adjacent to the inner edge of the bath rim to ensure effectiveness of the bottom seal / drip strip.

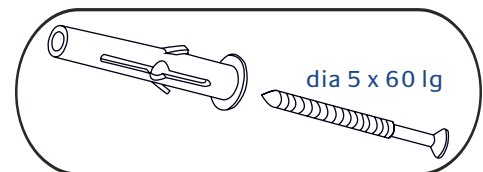

dia 5 x 60 lg

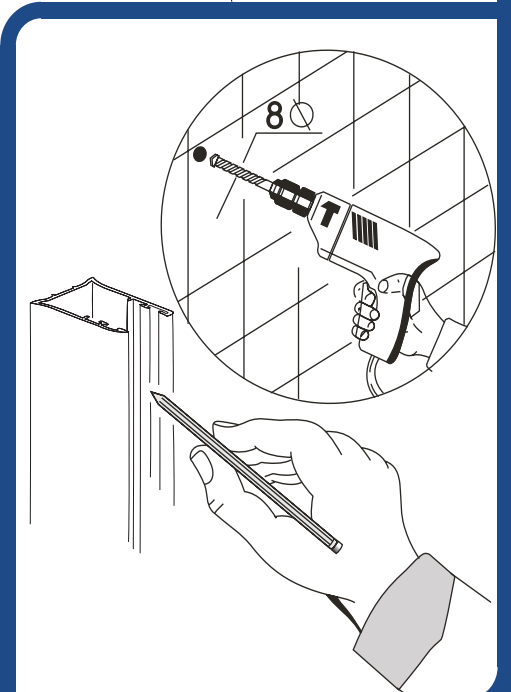

Measure & mark wall rail position.
 Wall rail orientation : Cross holes to inside (curved face outermost).
 Mark fixing hole positions, drill, plug & affix wall rail.
 (Back face of Wall profile may be siliconed before mounting).

B1

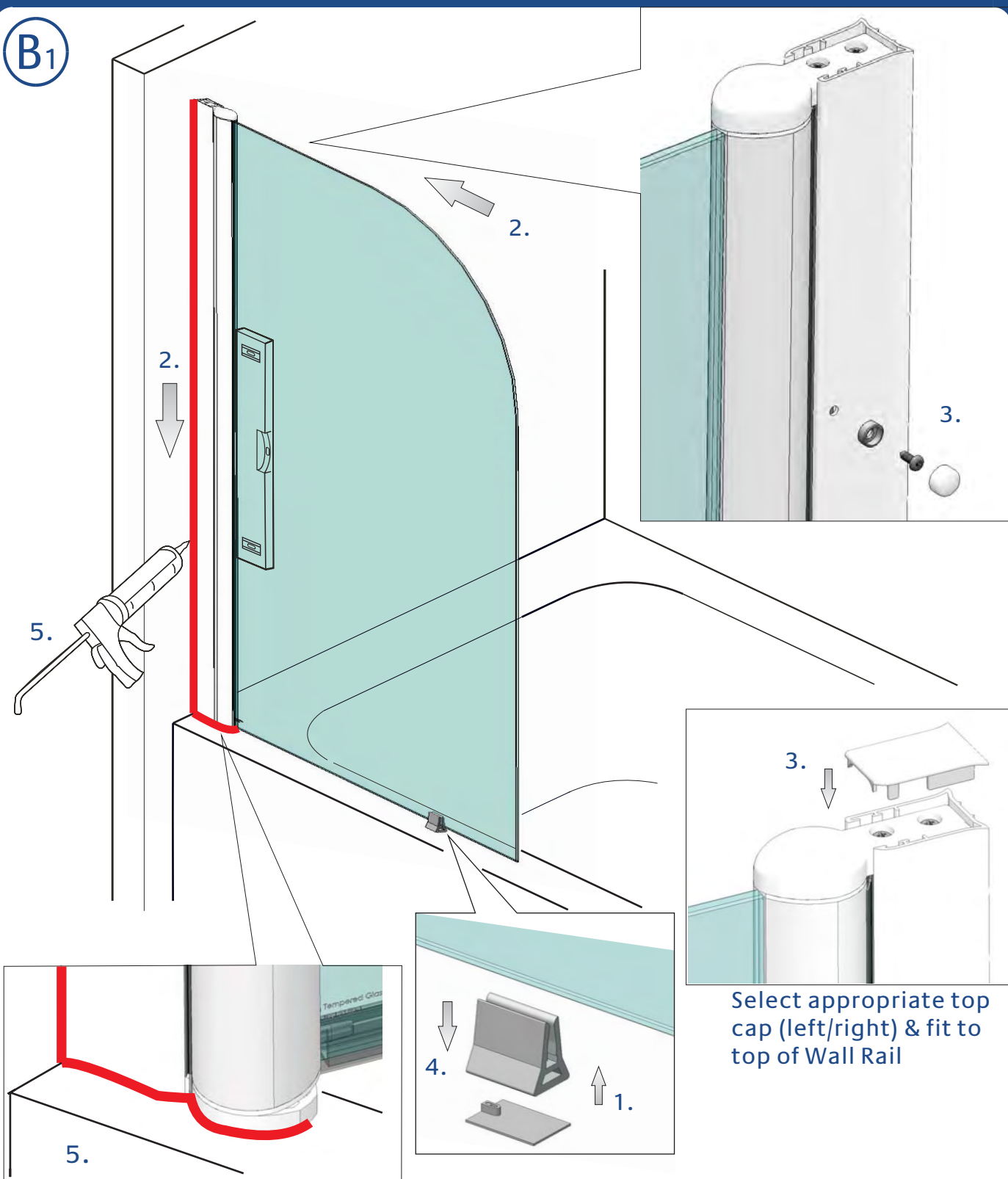

1. Push support & basepad onto bottom edge of glass toward outer end of screen.
2. Carefully lift screen into position & push into wall profile. Check bottom hinge bracket is sitting on bath rim & adjust screen for plumb.
3. From inside enclosure, using wall rail holes as a guide, drill (dia 3mm) fit cup washer & screw main screen to wall rail using 3,5 x 10 long pan head screws. Push on decorative cover caps (3 places) & fit Wall Rail top cap.
4. Once secure, move screen inward over bathtub, remove glass support / basepad & fit bottom seal (see B2).
5. With screen pushed inward over bathtub, apply continuous bead of silicone sealant as indicated EXTERNALLY ONLY.

B₂

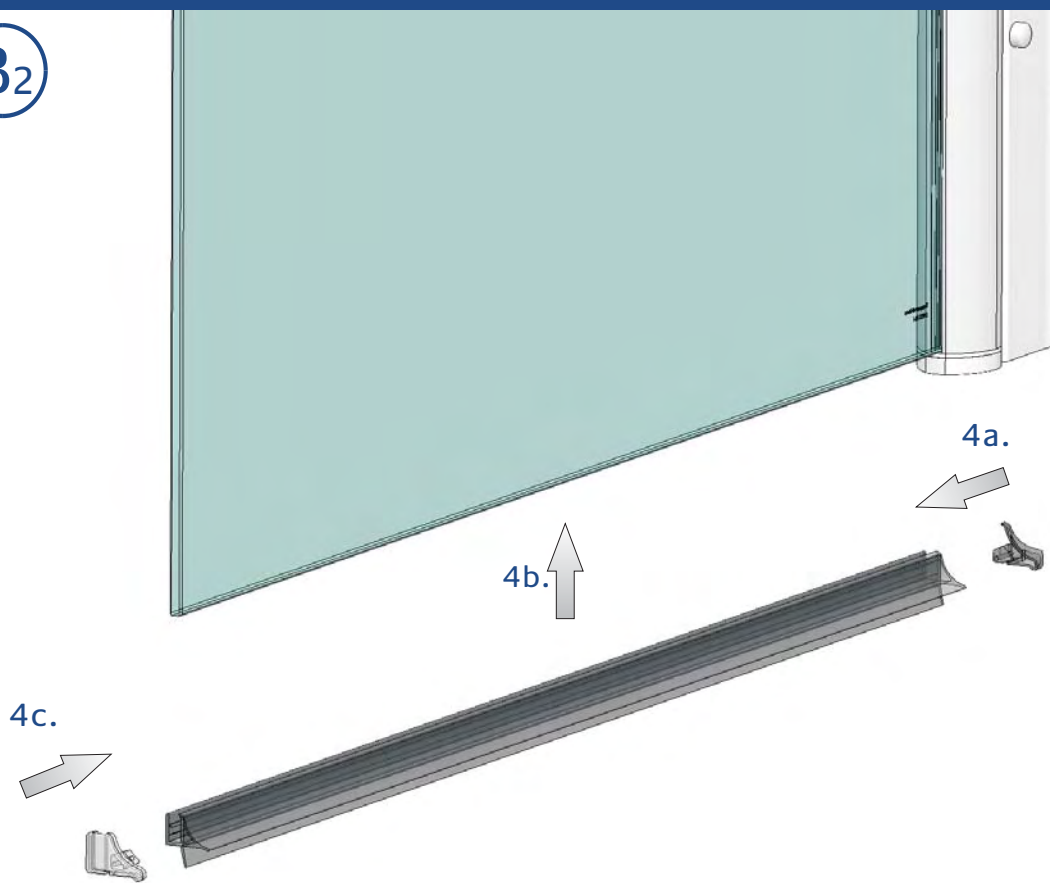

With 'drip strip' to inside, select appropriate hand seal end caps (left /right).

4a. Apply clear silicone sealant to hinge end cap & push into seal.

4b. Keeping hinge end cap against bottom hinge, push seal upward onto bottom edge of glass (Note : seal may be 'wetted' to ease fitting).

4c. Apply clear silicone sealant to outer end cap & push into seal & upto glass edge. Wipe off excess sealant with a damp cloth.

C

Towel Rail Models

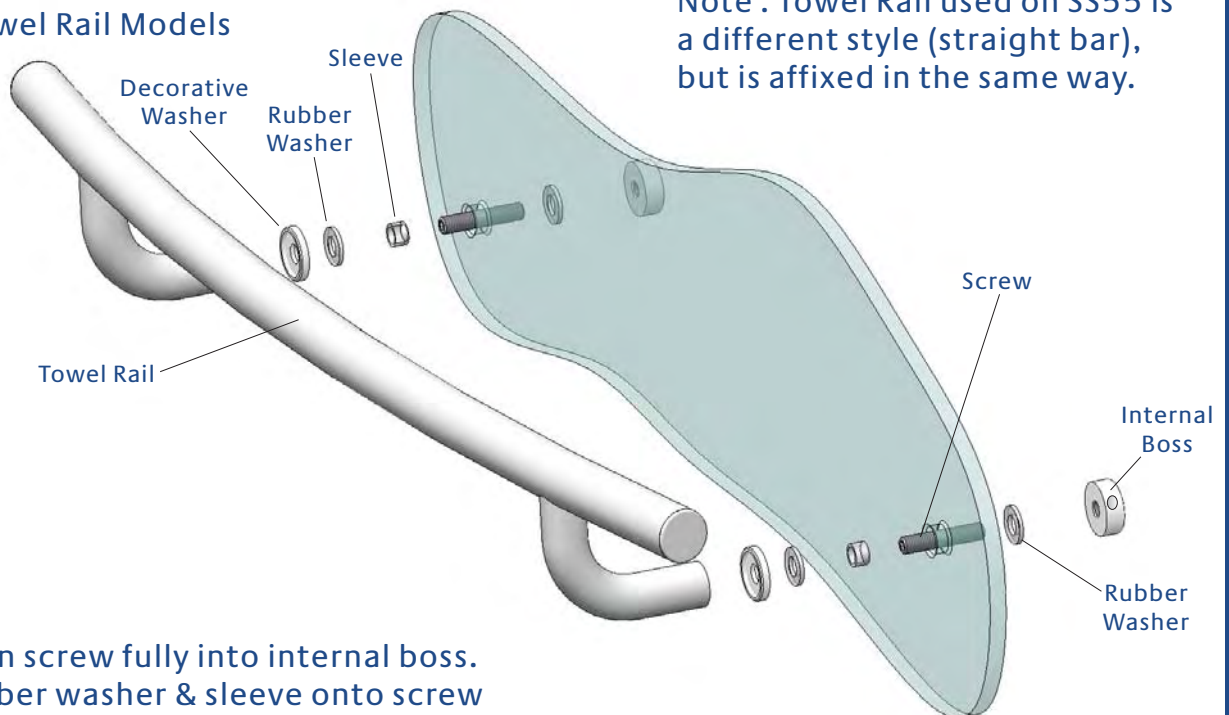

Note : Towel Rail used on SS55 is a different style (straight bar), but is affixed in the same way.

A) Tighten screw fully into internal boss.

B) Fit rubber washer & sleeve onto screw

C) Pass screw through glass, fit rubber washer & decorative washer onto screw then tighten screw into towel rail by turning internal boss until rail is secure. Additional tightening can be achieved by inserting (dia 2,8mm) drill bit or 2,5mm hexagon wrench (allen key) into the internal boss cross hole.

BASIC TROUBLESHOOTING :

Screen hinges noisy / not moving smoothly : Apply sanitary silicone based grease to hinge bearing inner diameters.

Check that hinge seals are not distorted or trapped in gap between profiles.

Leakage in area of bottom hinge : ensure bottom seal is pushed fully upto bottom hinge.

Water pooling on inside of screen : check 'fall' of bath rim is toward bathing area (certain bathtubs are unsuitable for screens of this type). Check also, that screen is positioned adjacent to the inner edge of the bath rim.

Leakage :

The sealing method described in these instructions relies on a continuous seal being applied between walls & bathtub before installing the screen (see fig A), it ensures a watertight seal around the perimeter of the bathtub to the walls.

In the unlikely event of a screen leak, water will be visible externally at the bottom of the screen or around the wall / bottom hinge ONLY. Water / moisture appearing outside this area (ie under the bathtub or at floor level) is normally due to incorrect bathtub installation / sealing.



Lakes Bathrooms Ltd
Alexandra Way
Ashchurch
Tewkesbury
Gloucestershire
GL20 8NB

Service : England, Scotland, Wales

8.30am—5pm Mon~ Thurs

8.30am—4.30pm Fri

Tel / HELPLINE : 01684 853870

Fax : 01684 857411

www.lakesbathrooms.co.uk

email : admin@lakesbathrooms.co.uk

Service : Northern Ireland

Ian A Kernohan

Firtrees

Green Way Industrial Estate

Conlig

Northern Ireland

BT23 7SU

8.30am - 5pm Mon~Thurs

8.30am - 4.30pm Fri

Tel : 02891 270233

Fax : 02891 270597

Email : info@iakonline.com