

FULLY FRAMED CORNER ENTRY Encl. (V1)

Installation / Maintenance Instructions

rev 01.19

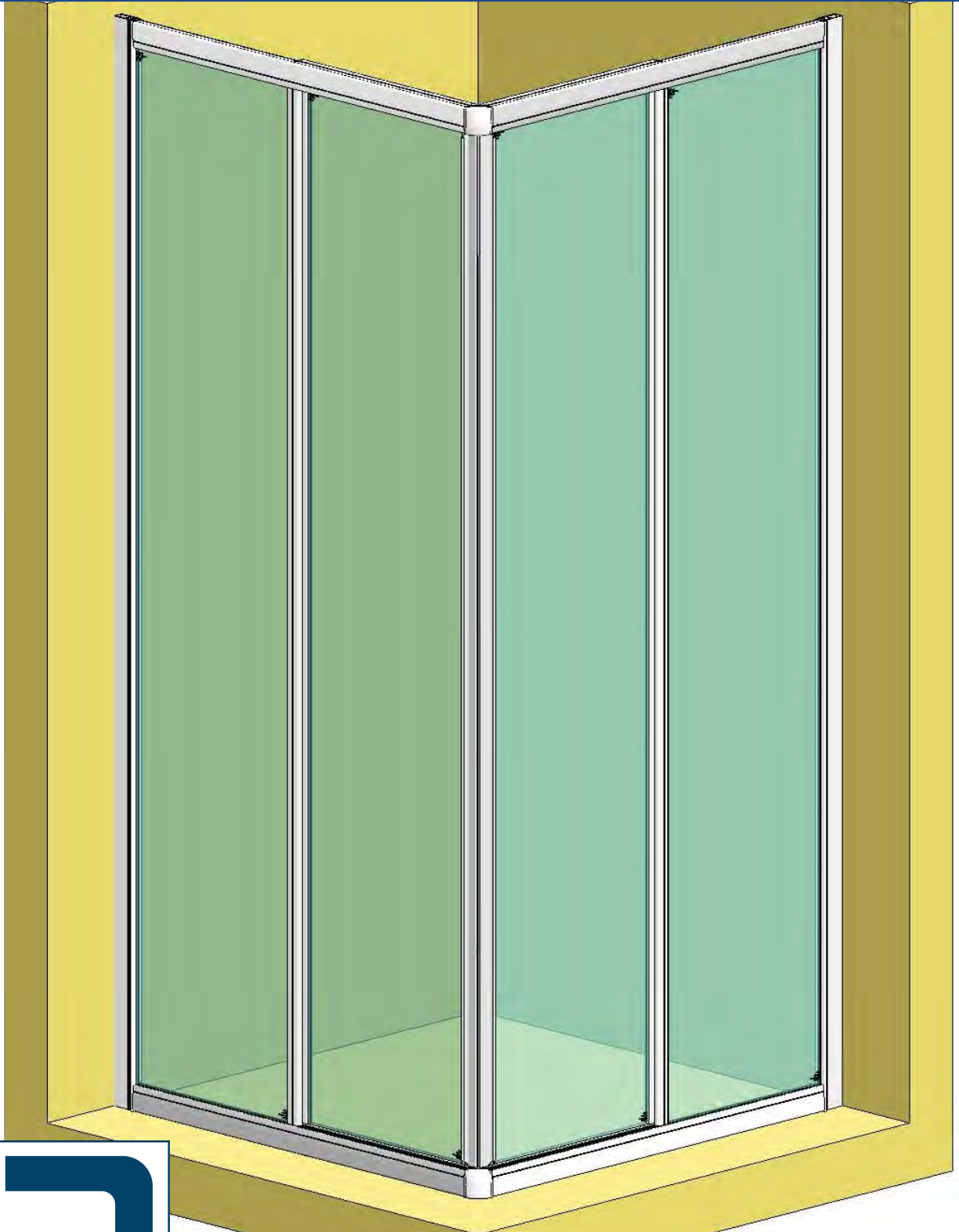

LAKES
SHOWERING SPACES

IMPORTANT NOTES :

Please Read Carefully & retain these instructions for Future Reference.

1. For ease & safety we advise that two persons assemble this product.
2. Protect shower tray surfaces at all times.
3. Exposed glass corners / edges MUST NOT contact hard surfaces at any time.
4. Check for cables, pipes etc before drilling walls.
5. Ensure all surfaces are dry, clean & free of loose debris / dust.
6. Unpack goods with care (small parts can become lodged in packaging & inadvertently discarded). Check parts supplied against parts & fittings listed herein. Damaged parts / omissions may be resolved by calling Lakes Bathrooms Helpline.
7. Whilst precautions are taken in manufacture, care must be taken when handling as rail ends may have sharp edges.
8. Before commencing, check :
 - a) shower tray (or base) is level & completely sealed to finished / tiled walls.
 - b) finished walls are sound & free of cracks, loose tiles / grout.
8. AFTER INSTALLATION, DO NOT 'WET' ENCLOSURE FOR 48 HOURS TO ENSURE FULL CURE OF SILICONE SEALANT.

USE :

General Care & Maintenance.

Provided this product is installed & operated in accordance with these instructions, problems should not arise. However should maintenance be required it should be carried out by a competent person with reference to these instructions. Before any work is carried out the root cause of the problem must be identified. Lakes Bathrooms service engineers are available if necessary to consult / carry out remedial work. Call Lakes Bathrooms HELPLINE.

Cleaning.

(Every one to two weeks depending on local water {hardness} conditions).

All glass panels in this product have a hydrophobic coating aiding 'runoff' of water droplets, reducing the need for frequent cleaning. For best appearance / product life however, regular cleaning is recommended.

Use ONLY mild soap / detergent solutions to clean. Rinse with water, squeegee glass panels & wipe frames dry with a soft cloth. Under no circumstances should abrasive, caustic or scouring products be used. Non compliance with these cleaning instructions may cause decorative finishes to deteriorate & could adversely affect safe operation of the enclosure.

Daily Care.

To prevent the build up of limescale, do not allow water droplets to dry on glass or frames. After showering, rinse with water, remove droplets from glass with a squeegee & wipe frame with a soft cloth.

Customer Service.

Quality Guarantee : Lakes Bathrooms Ltd guarantee Shower Doors & Enclosures against any manufacturing or material defects for the lifetime of the product. We will resolve defects free of charge by repairing / replacing parts as we feel necessary. To be 'free of charge' service work must be carried out by Lakes Bathrooms or approved agents.

Seals are considered 'wear & tear' parts, as such they are guaranteed for 12 months from purchase. Not Covered by this Guarantee : Damage or defects that result from improper installation, improper use, or lack of maintenance (including limescale buildup). Damage or defects that result from repairs / modifications undertaken by unauthorized persons. This guarantee is in addition to statutory & other legal rights.

What to do if something goes wrong : Should the product not function correctly on initial use, firstly, contact the installer to check that unit installation & commissioning are in accordance with these instructions. Should this not resolve difficulties or should performance decline, consult 'Troubleshooting' section to see if simple home maintenance is needed. Alternatively our HELPLINE staff can assist, or if necessary arrange for a service engineer to visit.

Spares : We maintain extensive spare part stocks. Spares can be ordered / purchased from your retailer in the first instance. Parts will normally be dispatched within two working days from order placement.

SUPPLIED PARTS :

Panel & Door Sub Assemblv (2x)

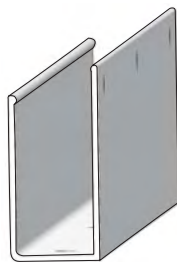
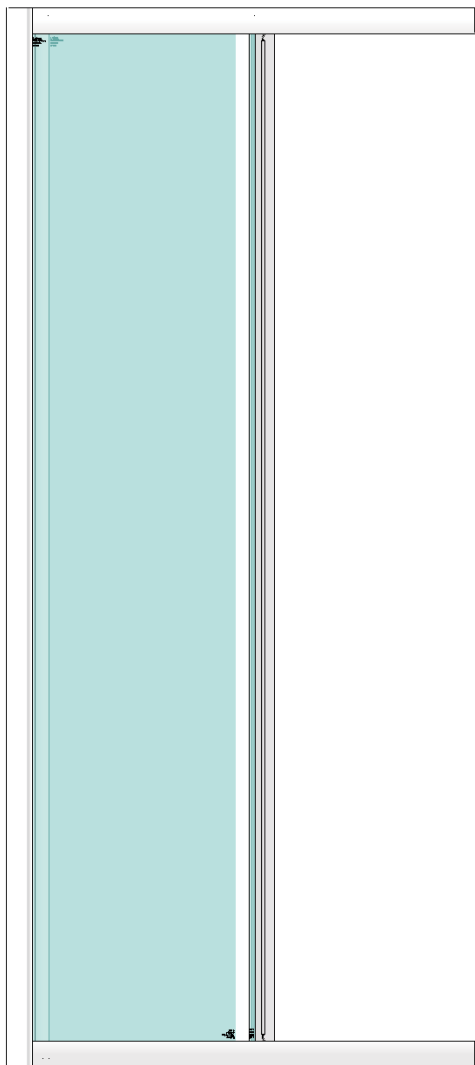

Wall Rail
(1850mm 2x)
fig A



Corner Cover (2x)
fig B

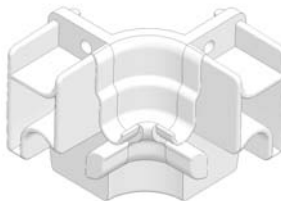

Corner Cleat (2x)
fig B



4 x 20 long self
tapping screw
(8x) fig B

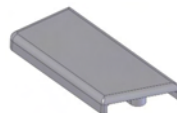

Top Cap (Wall rail)
(handed pair)

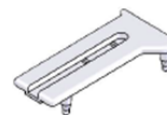

Top Cap (Vertical rail)
(handed pair)



4 x 45 long self
tapping screw (6x)
fig A



7,5 x 39mm Wall Plug
(6x) fig A



3.5 x 10 long self tapping
pan head screw (6x) fig C



Cup Washer (6x) fig C



Decorative Screw Cover
Cap (6x) fig C

REPLACEABLE ITEMS / SPARE PARTS :

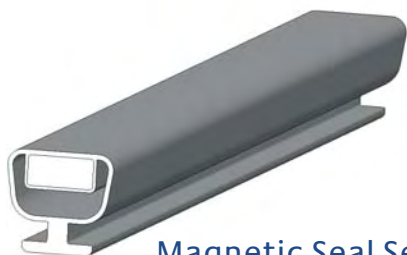

Magnetic Seal Set

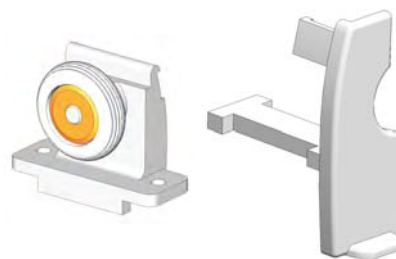

Door Wheels & End Caps



Doorstops

Size	Adjustment (A)
750mm	710 to 740mm
800mm	750 to 780mm
900mm	850 to 880mm

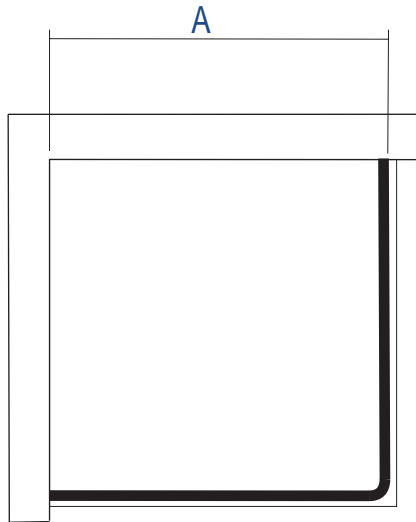

Tools Required

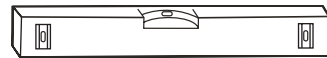

Spirit Level (with vertical 'bubble')

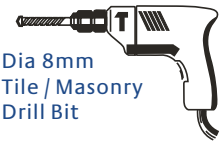

Dia 8mm
Tile / Masonry
Drill Bit



Tape
Measure



Pencil



Dia 3mm
HSS Drill Bit



Screwdriver (Pozi Drive)

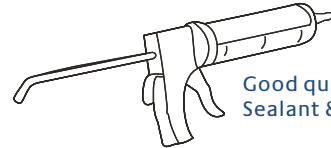

Good quality Silicone
Sealant & applicator

Ensure tray is correctly levelled & that tray / wall (tile) joints are sealed & cured over entire length of tray sides (See Fig A) prior to fitting enclosure.
DO NOT SEAL TRAY EDGES UPTO A FITTED ENCLOSURE !

A

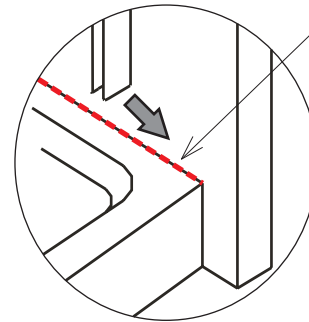
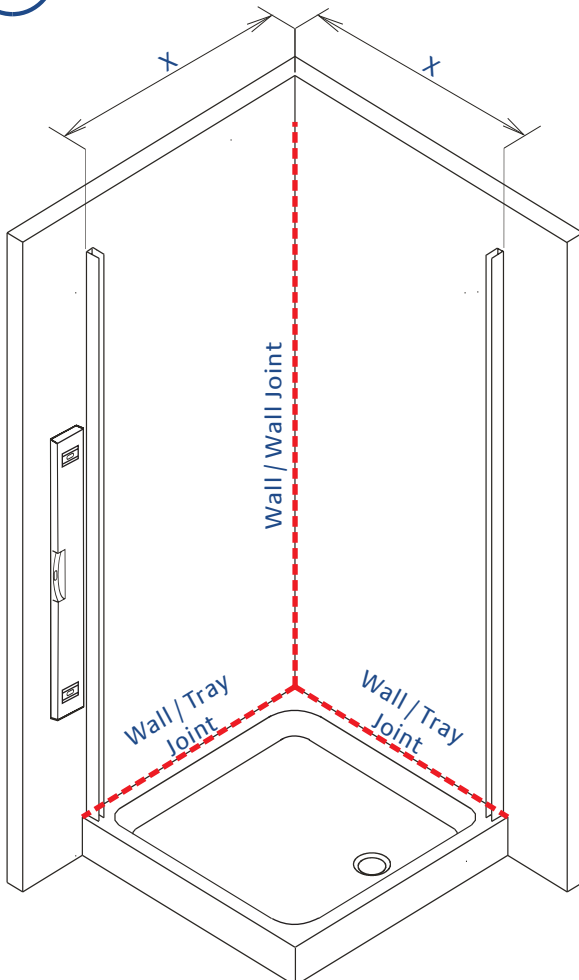

Ensure continuous
silicone sealant
bead before fitting
wall rails

Unit	X
750	725
800	765
900	865

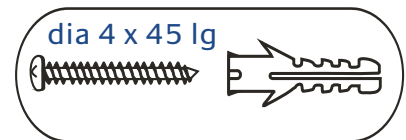

dia 4 x 45 lg

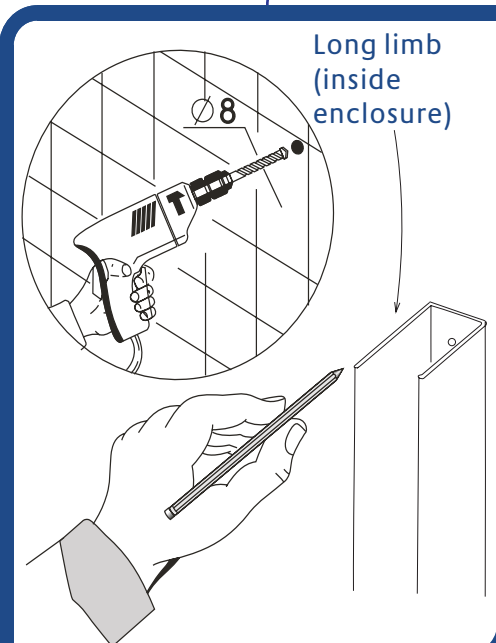

Long limb
(inside
enclosure)

Measure & mark wall rail Positions. Mark fixing hole positions, drill, plug walls & affix both Wall Rails

B

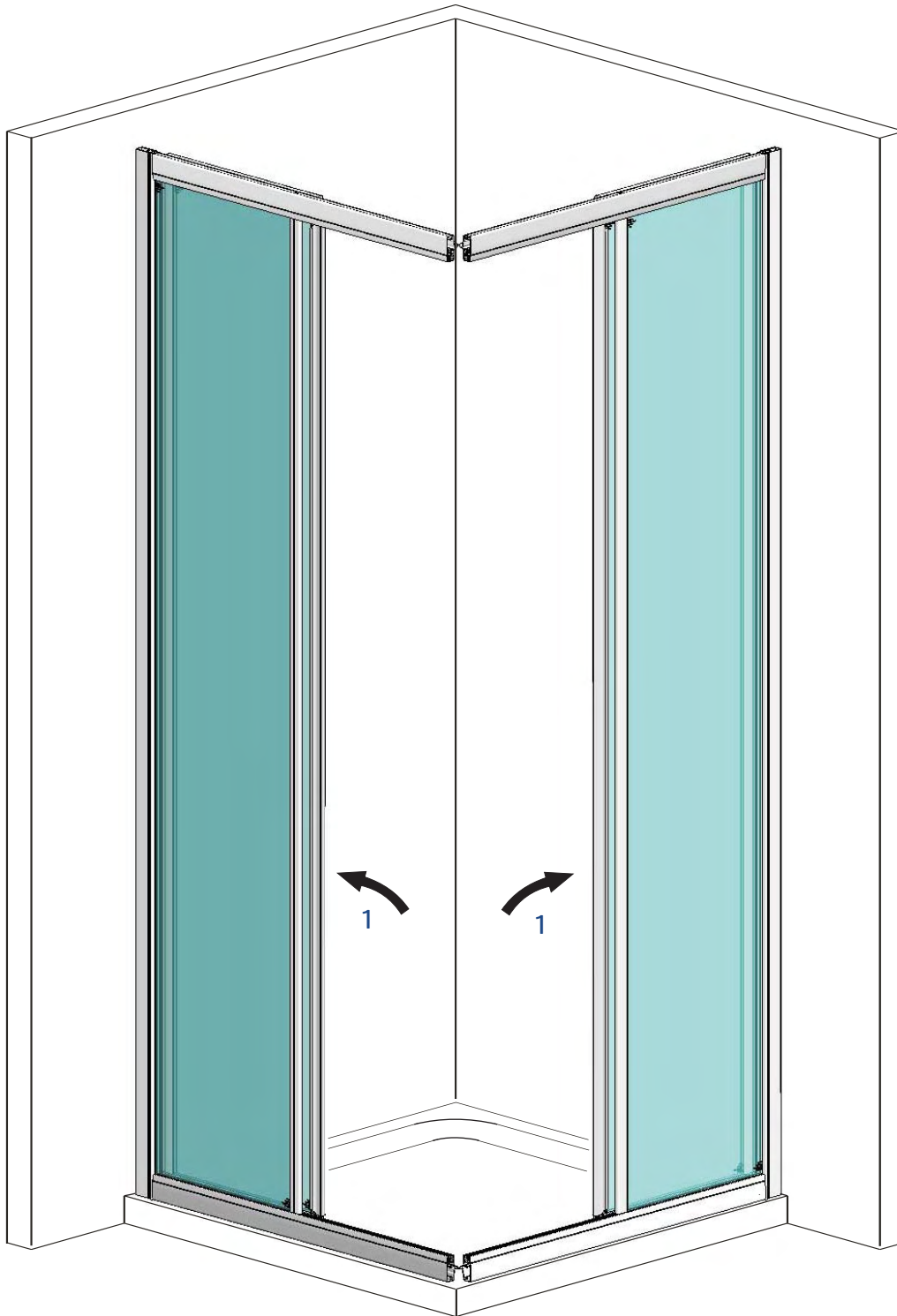

1. With doors in fully open position, carefully lift panel sub assemblies onto tray & push fully into wall profiles.

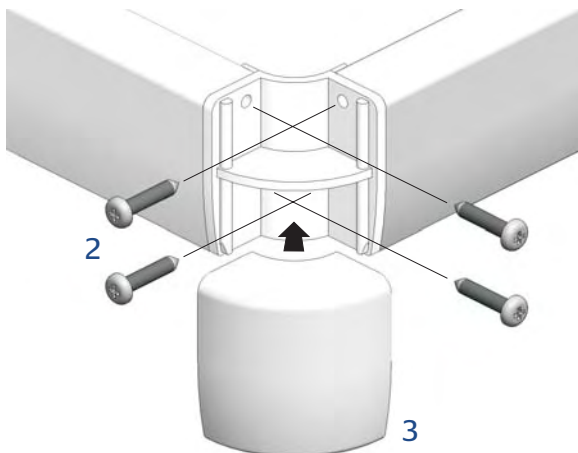

2. Fit corner cleats into open rail ends & secure with 4 x 20 long pan head screws (4 per cleat).
3. Align & push on decorative covers.

C

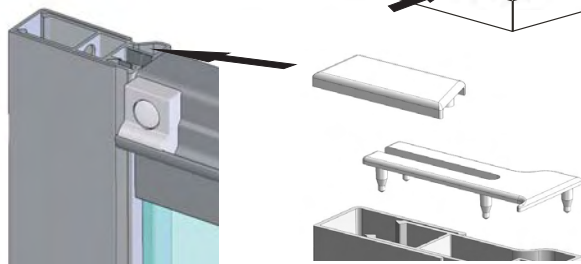
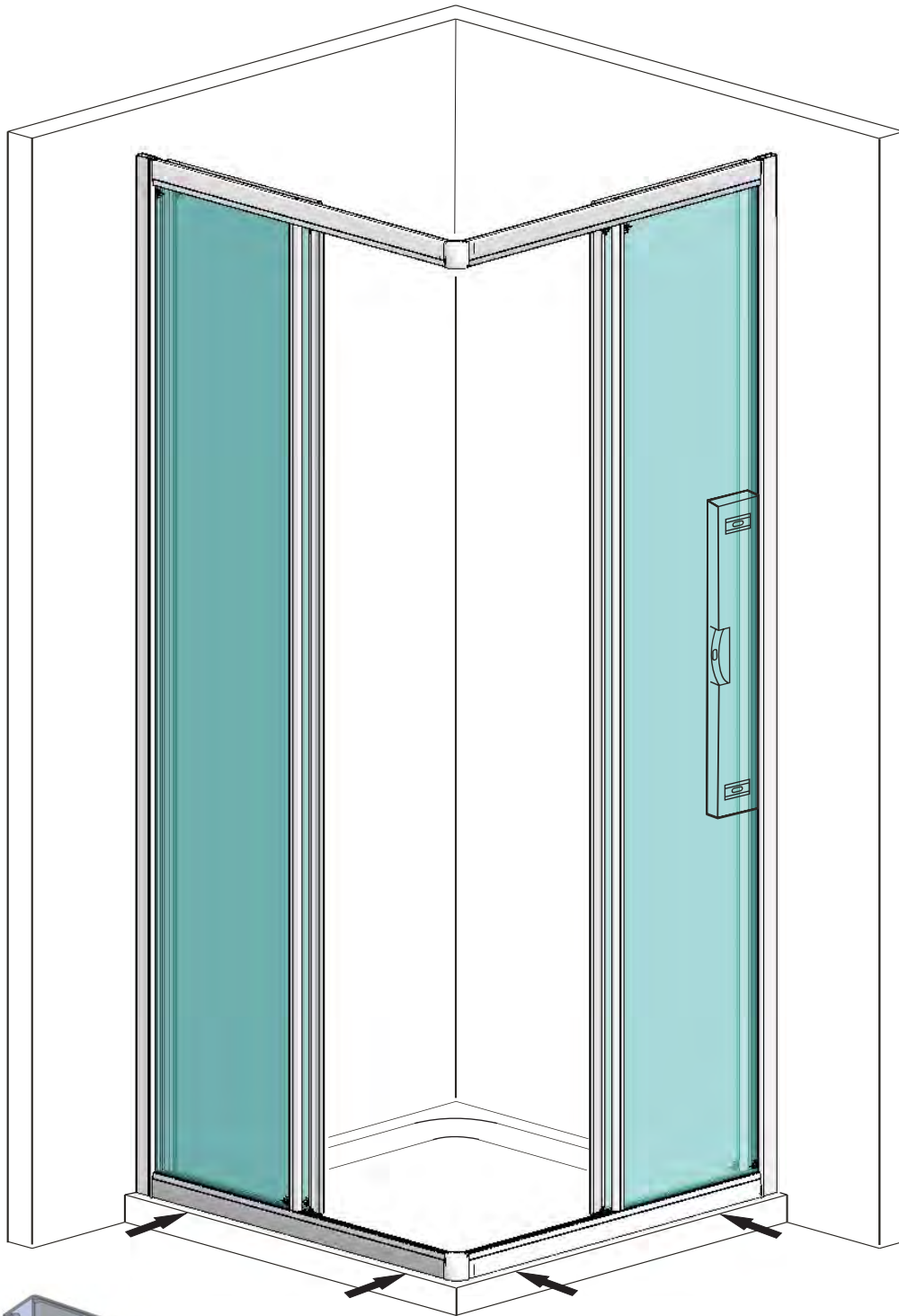

Fit vertical profile top cover caps

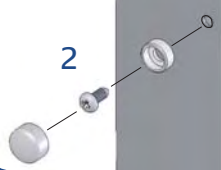

1. Adjust enclosure panels to give even gap to tray edge along both sides, ensure unit is plumb & that doors slide smoothly between stops.
2. From inside enclosure, using wall rail holes as a guide, drill (dia 2,8mm) fit cup washer & screw main panel to wall rail using 3,5 x 10 long pan head screws (3x per wall rail). Push on decorative cover caps to ALL screws/washers.

D

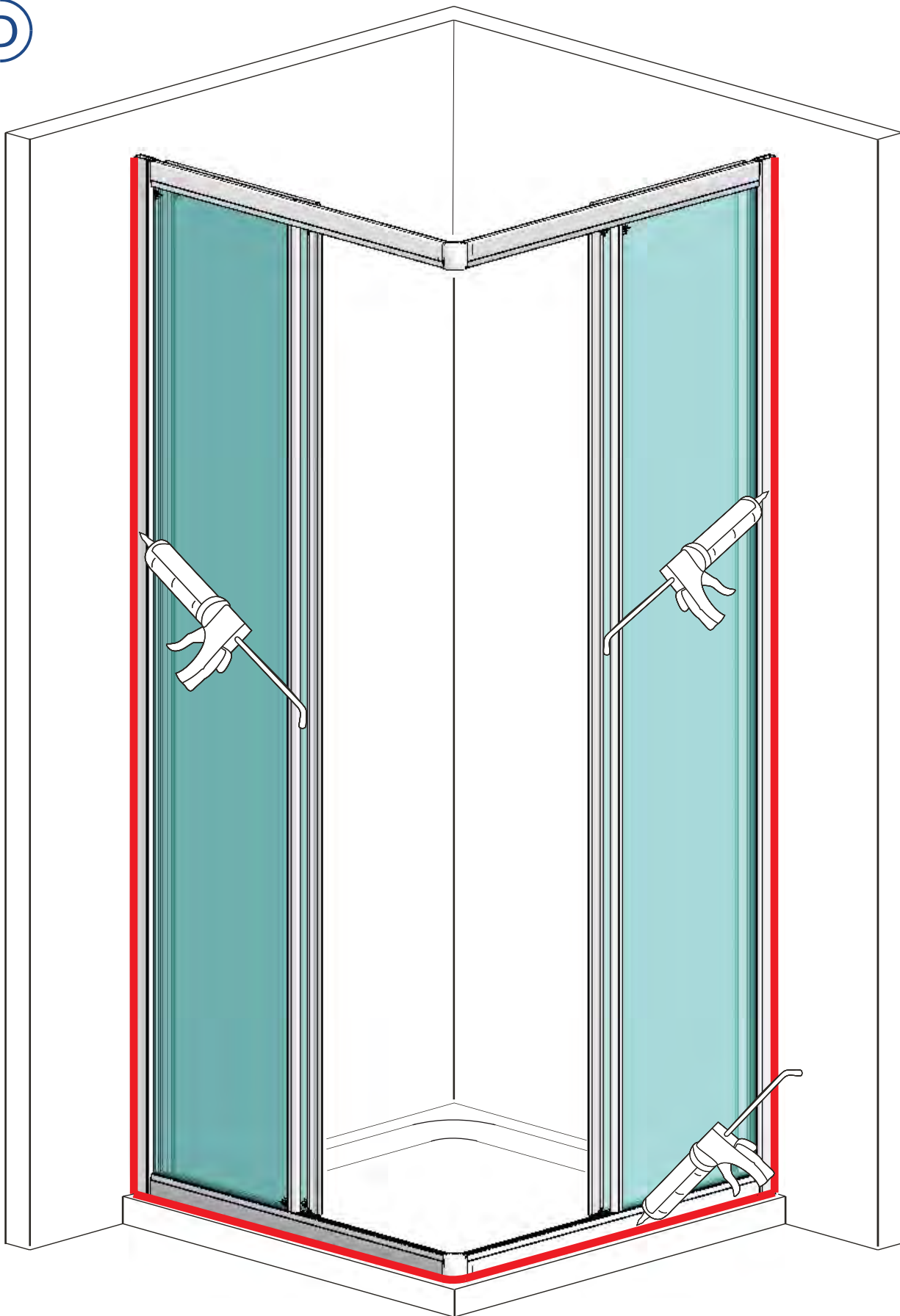

Use of good quality silicone sealant & cleaning / degreasing of all joint areas is recommended.
Apply continuous silicone sealant bead as indicated EXTERNALLY ONLY

BASIC TROUBLESHOOTING :

Door magnetic seals not meeting precisely / not holding :
Check plumb/level of frame & door alignment, adjust frame if necessary (see fig C).

Door motion noisy / Door not running smoothly :
Check for edge seals dragging on glass (can cause 'clicking' noise).
Wheels & Grooves are factory greased, however over time this may disperse or become contaminated by dust etc, cleaning of grooves & re application of sanitary silicone based grease will restore & ensure smooth door motion.

Leakage :

The sealing method described in these instructions relies on a continuous seal being applied between shower walls & tray before installing the enclosure (see fig A), it ensures a watertight seal around the perimeter of the enclosure to the shower walls & tray.

In the unlikely event of an enclosure leak, water will be visible on the outside of the enclosure itself, or around the perimeter silicone seal ONLY. Water / moisture appearing outside this area (ie at floor level) is normally due to incorrect tray installation.



Lakes Bathrooms Ltd
Alexandra Way
Ashchurch
Tewkesbury
Gloucestershire
GL20 8NB

Service : England, Scotland, Wales
8.30am—5pm Mon~ Thurs
8.30am—4.30pm Fri
Tel / HELPLINE : 01684 853870
Fax : 01684 857411
www.lakesbathrooms.co.uk
email : admin@lakesbathrooms.co.uk

Service : Northern Ireland
Ian A Kernohan
Firtrees
Green Way Industrial Estate
Conlig
Northern Ireland
BT23 7SU

8.30am - 5pm Mon~Thurs
8.30am - 4.30pm Fri
Tel : 02891 270233
Fax : 02891 270597
Email : info@iakonline.com